

SPECIAL TOOL CATALOGUE 2018

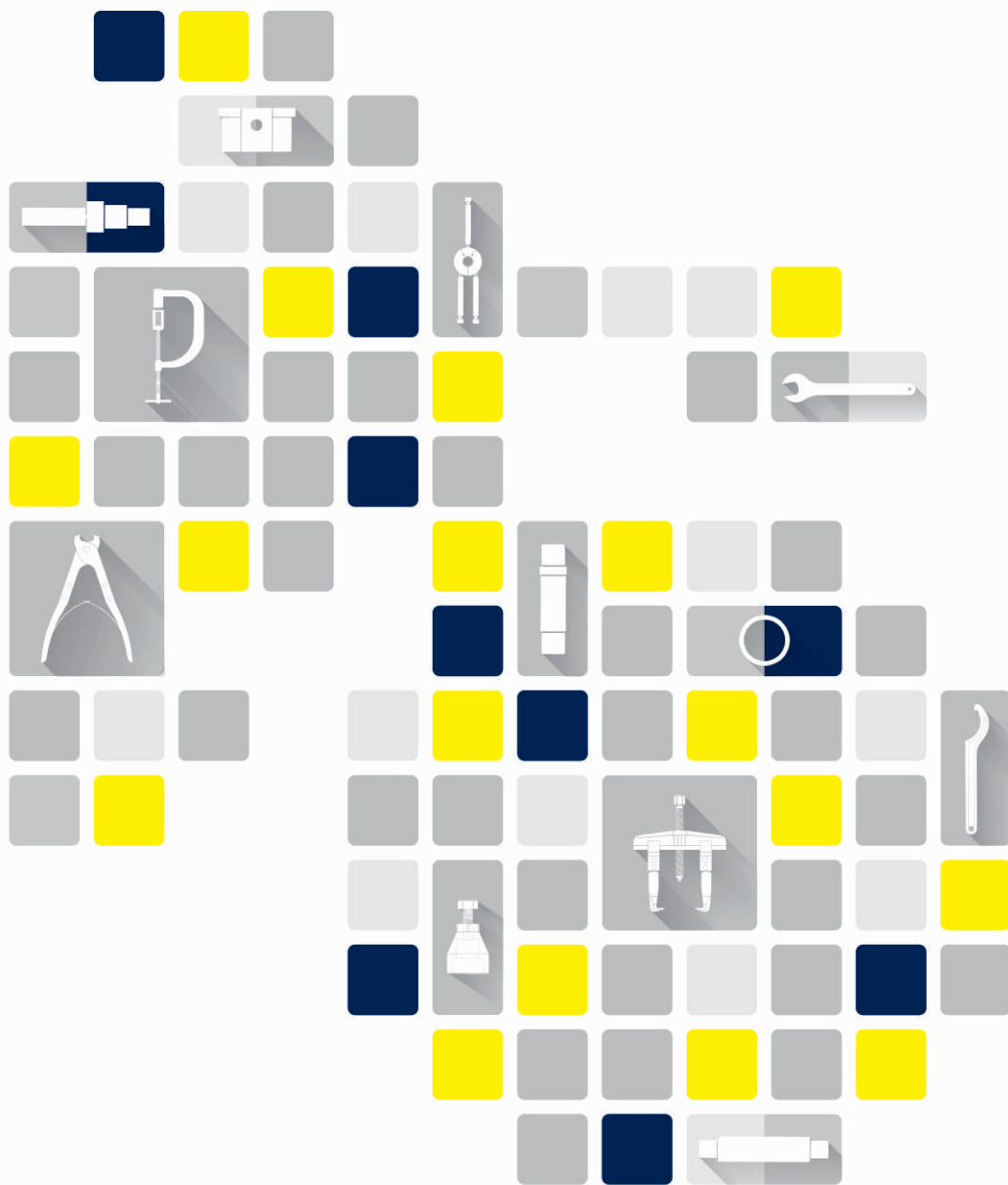

PIONEERING SINCE 1903 - to do justice to this claim requires appropriate and proven special tools. We have therefore compiled this catalogue for you, which contains all the tools for effective and efficient service or repairs.

This catalogue shows the special tools for model year 2014 to 2018.

Info

Tools in respect of which no information on their use is provided are optional tools.

The information contained in this catalogue was current at the time of going to print. However, minor differences due to further developments in design cannot be ruled out completely. It is planned to update the catalogue twice a year in future.

Husqvarna Motorcycles GmbH specifically reserves the right to modify or delete technical specifications, prices, colors, shapes, materials, services, designs, equipment, etc., without prior notice and without specifying reasons, to adapt these to local conditions, as well as to stop production of a particular tool without prior notice. Husqvarna accepts no liability for delivery options, deviations from figures and descriptions, as well as misprints and other errors.

© 2018 Husqvarna Motorcycles GmbH, Mattighofen Austria

All rights reserved

Reprinting, including excerpts, and duplication of any kind only with the written consent of the publisher.



ISO 9001(12 100 6061)

Husqvarna Motorcycles applies quality assurance processes that lead to the highest possible product quality as defined in the ISO 9001 international quality management standard.

Issued by: TÜV-Management Service

REG.NO. 12 100 6061

Husqvarna Motorcycles GmbH

Stallhofnerstraße 3

5230 Mattighofen, Austria



3403044en

12.06.2018

1	XC_1 NG.....	3	19.2	Wall tool organizer overview	103	
	1.1	Overview	3	20	FORK.....	105
2	XC_2.....	19	20.1	Wall tool organizer overview	105	
	2.1	Overview	19	21	SHOCK ABSORBER	120
3	ELECTRICAL SYSTEM / DIAGNOSIS	25	21.1	Overview	120	
	3.1	Overview	25	21.2	Wall tool organizer overview	121
	3.2	Wall tool organizer overview	30	22	PANELS & ACCESSORIES	130
4	BLEEDER TOOL.....	31	23	Product category: Husqvarna	136	
	4.1	Overview	31			
	4.2	Wall tool organizer overview	31			
5	ENGINE FIXING ARM.....	36				
	5.1	Overview	36			
	5.2	Wall tool organizer overview	37			
6	SUPPORT TOOL	42				
	6.1	Wall tool organizer overview	42			
7	MEASURING TOOL & SETTING GAUGE.....	49				
	7.1	Overview	49			
	7.2	Wall tool organizer overview	50			
8	EXTRACTOR TOOL.....	56				
	8.1	Wall tool organizer overview	56			
9	PROTECTING SLEEVES & PROTECTION CAPS.....	64				
	9.1	Wall tool organizer overview	64			
10	LIFT AND WORK STAND	67				
	10.1	Overview	67			
11	PLIERS	71				
	11.1	Wall tool organizer overview	71			
12	SPARK PLUG WRENCH	74				
	12.1	Wall tool organizer overview	74			
13	GROOVE NUT WRENCH	76				
	13.1	Wall tool organizer overview	76			
14	CRANKSHAFT PRESSING TOOL	77				
	14.1	Overview	77			
15	PISTON TOOL.....	88				
	15.1	Wall tool organizer overview	88			
16	TRANSMISSION TOOL	90				
	16.1	Wall tool organizer overview	90			
17	VALVE AND TIMING TOOL	92				
	17.1	Overview	92			
	17.2	Wall tool organizer overview	92			
18	PRESSING TOOL.....	97				
	18.1	Wall tool organizer overview	97			
19	OTHER TOOLS.....	103				
	19.1	Overview	103			

1.1 Overview

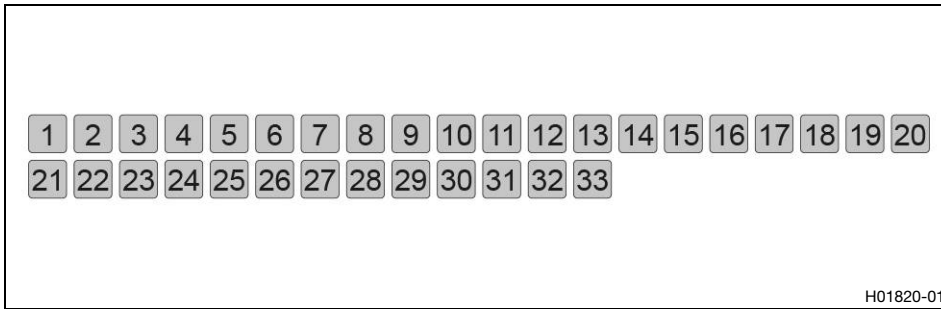

H01820-01

1	VCI 1000 (00029094001) (p. 4)
2	Protective cover for VCI 1000 (00029094002) (p. 4)
3	VCI 1000 power supply cable (00029094003) (p. 4)
4	Diagnostics cable extension (00029094004) (p. 5)
5	USB cable (00029094005) (p. 5)
6	Power supply unit VCI 1000 (00029094006) (p. 6)
7	EU power cord (00029094007) (p. 6)
8	UK power cord (00029094008) (p. 6)
9	US power cord (00029094009) (p. 7)
10	Panasonic CF-D1 battery charger (00029094010) (p. 7)
11	Input stylus (00029094011) (p. 7)
12	Battery (00029094012) (p. 8)
13	Case (00029094013) (p. 8)
14	Protective film (00029094015) (p. 9)
15	Stand (00029094016) (p. 9)
16	Panasonic CF-D1 (00029094017) (p. 9)
17	Diagnosis adapter cable (00029094019) (p. 10)
18	License key (00029094020) (p. 10)
19	Black test terminal (00029094021) (p. 10)
20	Red test terminal (00029094022) (p. 11)
21	Black measurement cable (00029094023) (p. 11)
22	Red measurement cable (00029094024) (p. 12)
23	Husqvarna Motorcycles sticker set (00029094025) (p. 12)
24	Handle (00029094026) (p. 12)
25	Docking station (00029094027) (p. 13)
26	Diagnosis adapter cable (00029094028) (p. 13)
27	XC_1 NG DE (00029296000DE) (p. 13)
28	XC_1 NG EN (00029296000EN) (p. 14)
29	XC_1 NG US (00029296000US) (p. 15)
30	XC_1 NG IT (00029296000IT) (p. 15)
31	XC_1 NG FR (00029296000FR) (p. 16)
32	XC_1 NG ES (00029296000ES) (p. 17)
33	XC_1 NG JP (00029296000JP) (p. 17)

00029094001 VCI 1000

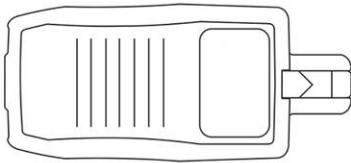

00029094001

Description/example of use

The Vehicle Communication Interface (VCI) is connected to the diagnostic connector of the vehicle and the diagnostic computer

for use with

- 00029296000DE
- 00029296000EN
- 00029296000US
- 00029296000IT
- 00029296000FR
- 00029296000ES
- 00029296000JP

used with model

- MX1 4 stroke
- MX2 4 stroke
- Enduro E1 4 stroke
- Enduro E2 4 stroke
- Enduro E3 4 stroke
- Rally
- Street

Spare parts

00029094002 Protective cover for VCI 1000

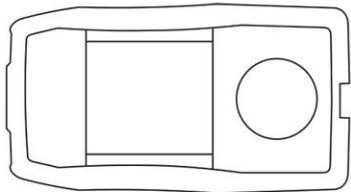

00029094002

Description/example of use

Silicone sleeve to protect the VCI 1000

for use with

- 00029296000DE
- 00029296000EN
- 00029296000US
- 00029296000IT
- 00029296000FR
- 00029296000ES
- 00029296000JP

used with model

- MX1 4 stroke
- MX2 4 stroke
- Enduro E1 4 stroke
- Enduro E2 4 stroke
- Enduro E3 4 stroke
- Rally
- Street

Spare parts

00029094003 VCI 1000 power supply cable

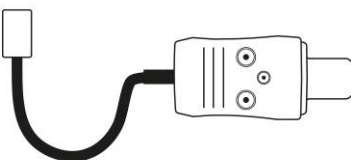

00029094003

Description/example of use

External power supply for the VCI 1000 for vehicles without battery and for flashing

for use with

- 00029296000DE
- 00029296000EN
- 00029296000US
- 00029296000IT
- 00029296000FR
- 00029296000ES
- 00029296000JP

00029094003 VCI 1000 power supply cable	
	used with model MX1 4 stroke MX2 4 stroke Enduro E1 4 stroke Enduro E2 4 stroke Enduro E3 4 stroke Rally Street
	Spare parts

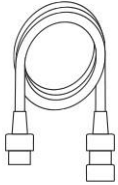
00029094004 Diagnostics cable extension	
 <p>00029094004</p>	<p>Description/example of use Extension cables between VCI 1000 and diagnostic connector on the vehicle</p> <p>Technical data Length approx.: 1.15 m (3.77 ft)</p> <p>used with model MX1 4 stroke MX2 4 stroke Enduro E1 4 stroke Enduro E2 4 stroke Enduro E3 4 stroke Rally Street</p>
	<p>for use with</p> <ul style="list-style-type: none"> 00029296000DE 00029296000EN 00029296000US 00029296000IT 00029296000FR 00029296000ES 00029296000JP <p>Spare parts</p>

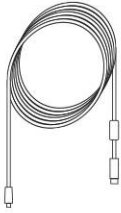

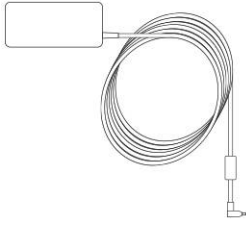
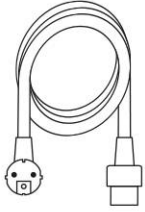
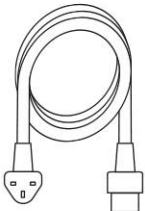
00029094005 USB cable	
 <p>00029094005</p>	<p>Description/example of use USB cable type A to type B mini (diagnostics tablet to VCI)</p> <p>Technical data Length approx.: 5 m (16 ft)</p> <p>used with model MX1 4 stroke MX2 4 stroke Enduro E1 4 stroke Enduro E2 4 stroke Enduro E3 4 stroke Rally Street</p>
	<p>for use with</p> <ul style="list-style-type: none"> 00029296000DE 00029296000EN 00029296000US 00029296000IT 00029296000FR 00029296000ES 00029296000JP <p>Spare parts</p>

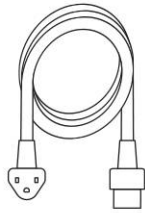

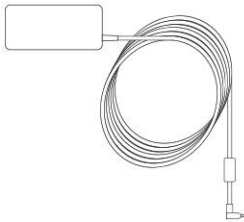
00029094006 Power supply unit VCI 1000	
 <p>00029094006</p>	<p>Description/example of use</p> <p>Power supply unit for VCI 1000</p> <p>Technical data</p> <p>Power output: 12 V</p> <p>Power output: 1.25 A</p> <p>for use with</p> <p>00029296000DE</p> <p>00029296000EN</p> <p>00029296000US</p> <p>00029296000IT</p> <p>00029296000FR</p> <p>00029296000ES</p> <p>00029296000JP</p> <p>used with model</p> <p>MX1 4 stroke</p> <p>MX2 4 stroke</p> <p>Enduro E1 4 stroke</p> <p>Enduro E2 4 stroke</p> <p>Enduro E3 4 stroke</p> <p>Rally</p> <p>Street</p>
Spare parts	
00029094007 EU power cord	
 <p>00029094007</p>	<p>Description/example of use</p> <p>Power cord with EU safety plug for connecting the VCI 1000 power supply</p> <p>Technical data</p> <p>Length approx.: 1.8 m (5.9 ft)</p> <p>for use with</p> <p>00029296000DE</p> <p>00029296000IT</p> <p>00029296000FR</p> <p>00029296000ES</p> <p>used with model</p> <p>MX1 4 stroke</p> <p>MX2 4 stroke</p> <p>Enduro E1 4 stroke</p> <p>Enduro E2 4 stroke</p> <p>Enduro E3 4 stroke</p> <p>Rally</p> <p>Street</p>
Spare parts	
00029094008 UK power cord	
 <p>00029094008</p>	<p>Description/example of use</p> <p>Power cord with UK safety plug for connecting the VCI 1000 power supply</p> <p>Technical data</p> <p>Length approx.: 1.8 m (5.9 ft)</p> <p>for use with</p> <p>00029296000EN</p> <p>used with model</p> <p>MX1 4 stroke</p> <p>MX2 4 stroke</p> <p>Enduro E1 4 stroke</p> <p>Enduro E2 4 stroke</p> <p>Enduro E3 4 stroke</p> <p>Rally</p> <p>Street</p>
Spare parts	

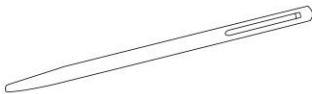
00029094009 US power cord	
 <p>00029094009</p>	<p>Description/example of use</p> <p>Power cord with US safety plug for connecting the VCI 1000 power supply</p> <p>Technical data for use with</p> <p>Length approx.: 1.8 m (5.9 ft) 00029296000US</p> <p style="text-align: right;">00029296000JP</p> <p>used with model</p> <p>MX1 4 stroke</p> <p>MX2 4 stroke</p> <p>Enduro E1 4 stroke</p> <p>Enduro E2 4 stroke</p> <p>Enduro E3 4 stroke</p> <p>Rally</p> <p>Street</p>
	Spare parts

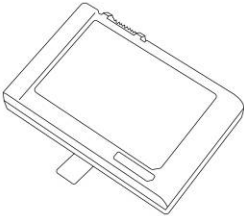
00029094010 Panasonic CF-D1 battery charger	
 <p>00029094010</p>	<p>Description/example of use</p> <p>Battery charger and power supply unit for Panasonic CF-D1 diagnostics tablet</p> <p>Technical data for use with</p> <p>Power output: 15.6 V 00029296000DE</p> <p>Power output: 7.05 A 00029296000EN</p> <p style="text-align: right;">00029296000US</p> <p style="text-align: right;">00029296000IT</p> <p style="text-align: right;">00029296000FR</p> <p style="text-align: right;">00029296000ES</p> <p style="text-align: right;">00029296000JP</p> <p>used with model</p> <p>MX1 4 stroke</p> <p>MX2 4 stroke</p> <p>Enduro E1 4 stroke</p> <p>Enduro E2 4 stroke</p> <p>Enduro E3 4 stroke</p> <p>Rally</p> <p>Street</p>
	Spare parts

00029094011 Input stylus	
 <p>00029094011</p>	<p>Description/example of use</p> <p>Stylus for input via the touch screen of the Panasonic CF-D1 diagnostics tablet</p> <p style="text-align: right;">for use with</p> <p style="text-align: right;">00029296000DE</p> <p style="text-align: right;">00029296000EN</p> <p style="text-align: right;">00029296000US</p> <p style="text-align: right;">00029296000IT</p> <p style="text-align: right;">00029296000FR</p> <p style="text-align: right;">00029296000ES</p> <p style="text-align: right;">00029296000JP</p> <p>used with model</p> <p>MX1 4 stroke</p> <p>MX2 4 stroke</p> <p>Enduro E1 4 stroke</p> <p>Enduro E2 4 stroke</p>

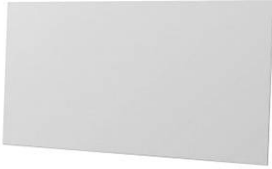
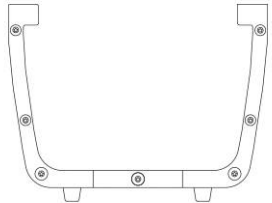
00029094011 Input stylus	
	Enduro E3 4 stroke Rally Street Spare parts
00029094012 Battery	
 <p style="text-align: center;">00029094012</p>	Description/example of use Battery for Panasonic CF-D1 diagnostics tablet <div style="text-align: right;"> for use with 00029296000DE 00029296000EN 00029296000US 00029296000IT 00029296000FR 00029296000ES 00029296000JP </div> used with model MX1 4 stroke MX2 4 stroke Enduro E1 4 stroke Enduro E2 4 stroke Enduro E3 4 stroke Rally Street Spare parts
00029094013 Case	
 <p style="text-align: center;">00029094013</p>	Description/example of use Case including inlay for storing the VCI 1000 and all the cables and adapters for diagnosis <div style="text-align: right;"> for use with 00029296000DE 00029296000EN 00029296000US 00029296000IT 00029296000FR 00029296000ES 00029296000JP </div> used with model MX1 4 stroke MX2 4 stroke Enduro E1 4 stroke Enduro E2 4 stroke Enduro E3 4 stroke Rally Street Spare parts

00029094015 Protective film		
 <p>00029094015</p>	Description/example of use Protective film for the touchscreen of Panasonic CF-D1 diagnostics tablet for use with 00029296000DE 00029296000EN 00029296000US 00029296000IT 00029296000FR 00029296000ES 00029296000JP	
	Service <input type="checkbox"/>	Repair <input type="checkbox"/>
00029094016 Stand		
 <p>00029094016</p>	Description/example of use Stand for Panasonic CF-D1 diagnostics tablet for use with 00029296000DE 00029296000EN 00029296000US 00029296000IT 00029296000FR 00029296000ES 00029296000JP	
	Service <input type="checkbox"/>	Repair <input type="checkbox"/>
00029094017 Panasonic CF-D1		
 <p>00029094017</p>	Description/example of use Tablet computer with the software for vehicle diagnostics (without license key) for use with 00029296000DE 00029296000EN 00029296000US 00029296000IT 00029296000FR 00029296000ES 00029296000JP	
	used with model MX1 4 stroke MX2 4 stroke Enduro E1 4 stroke Enduro E2 4 stroke Enduro E3 4 stroke Rally Street	
Spare parts		

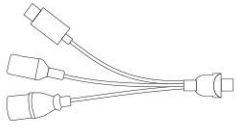
00029094019 Diagnosis adapter cable		
 <p>00029094019</p>	Description/example of use Adapter for connection to Husqvarna RED vehicle	
	for use with 00029296000DE 00029296000EN 00029296000US 00029296000IT 00029296000FR 00029296000ES 00029296000JP 00029XC2	
Service	<input type="checkbox"/>	Repair
		optional
		<input checked="" type="checkbox"/>

00029094020 License key		
 <p>00029094020</p>	Description/example of use Corresponding license key for the vehicle diagnostics software	
	for use with 00029296000DE 00029296000EN 00029296000US 00029296000IT 00029296000FR 00029296000ES 00029296000JP	
used with model MX1 4 stroke MX2 4 stroke Enduro E1 4 stroke Enduro E2 4 stroke Enduro E3 4 stroke Rally Street		
Service	<input checked="" type="checkbox"/>	Repair
		optional
		<input type="checkbox"/>

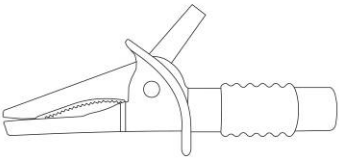
00029094021 Black test terminal		
 <p>00029094021</p>	Description/example of use Test terminal for connecting the measurement cable	
	Technical data 4 mm (0.16 in) Color: Black	
for use with 00029296000DE 00029296000EN 00029296000US 00029296000IT 00029296000FR 00029296000ES 00029296000JP		
used with model MX1 4 stroke MX2 4 stroke Enduro E1 4 stroke Enduro E2 4 stroke		

00029094021 Black test terminal	
	Enduro E3 4 stroke Rally Street
	Spare parts

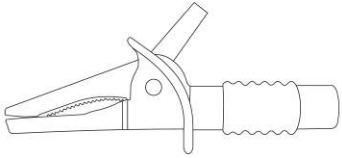
00029094022 Red test terminal	
 <p>00029094022</p>	<p>Description/example of use</p> <p>Test terminal for connecting the measurement cable</p> <p>Technical data</p> <p>4 mm (0.16 in)</p> <p>Color: Red</p>
	<p>for use with</p> <p>00029296000DE 00029296000EN 00029296000US 00029296000IT 00029296000FR 00029296000ES 00029296000JP</p> <p>used with model</p> <p>MX1 4 stroke MX2 4 stroke Enduro E1 4 stroke Enduro E2 4 stroke Enduro E3 4 stroke Rally Street</p>
Spare parts	

00029094023 Black measurement cable	
 <p>00029094023</p>	<p>Description/example of use</p> <p>Measurement cable with 4 mm banana plug</p> <p>Technical data</p> <p>Length approx.: 2 m (7 ft)</p> <p>Color: Black</p>
	<p>for use with</p> <p>00029296000DE 00029296000EN 00029296000US 00029296000IT 00029296000FR 00029296000ES 00029296000JP</p> <p>used with model</p> <p>MX1 4 stroke MX2 4 stroke Enduro E1 4 stroke Enduro E2 4 stroke Enduro E3 4 stroke Rally Street</p>
Spare parts	

00029094024 Red measurement cable

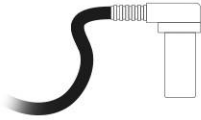
 <p>00029094024</p>	<p>Description/example of use Measurement cable with 4 mm banana plug</p> <p>Technical data Length approx.: 2 m (7 ft) Color: Red</p> <p>for use with 00029296000DE 00029296000EN 00029296000US 00029296000IT 00029296000FR 00029296000ES 00029296000JP</p> <p>used with model MX1 4 stroke MX2 4 stroke Enduro E1 4 stroke Enduro E2 4 stroke Enduro E3 4 stroke Rally Street</p>
	<p>Spare parts</p>

00029094025 Husqvarna Motorcycles sticker set

 <p>00029094025</p>	<p>Description/example of use Sticker set with Husqvarna Motorcycles branding</p> <p>for use with 00029296000DE 00029296000EN 00029296000US 00029296000IT 00029296000FR 00029296000ES 00029296000JP</p> <p>used with model MX1 4 stroke MX2 4 stroke Enduro E1 4 stroke Enduro E2 4 stroke Enduro E3 4 stroke Rally Street</p>
	<p>Spare parts</p>

00029094026 Handle

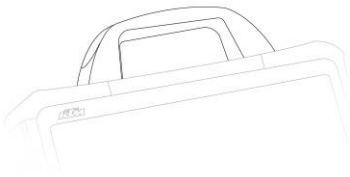
 <p>00029094026</p>	<p>Description/example of use Handle for Panasonic CF-D1 diagnostics tablet</p> <p>for use with 00029296000DE 00029296000EN 00029296000US 00029296000IT 00029296000FR 00029296000ES 00029296000JP</p> <p>used with model</p>
--	--

00029094026 Handle	
	MX1 4 stroke MX2 4 stroke Enduro E1 4 stroke Enduro E2 4 stroke Enduro E3 4 stroke Rally Street
	Spare parts

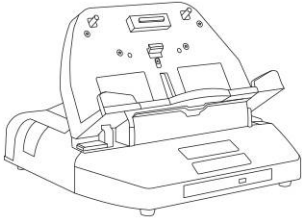
00029094027 Docking station	
 <p>00029094027</p>	Description/example of use Docking station for Panasonic CF-D1 diagnostics tablet Technical data With DVD player
	for use with 00029296000DE 00029296000EN 00029296000US 00029296000IT 00029296000FR 00029296000ES 00029296000JP
Service <input type="checkbox"/>	Repair <input type="checkbox"/> optional <input checked="" type="checkbox"/>

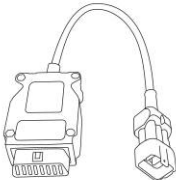
00029094028 Diagnosis adapter cable	
 <p>00029094028</p>	Description/example of use Adapter cable for connecting a standardized VCI (Pass Thru) with OBD connector Technical data Length approx.: 35 cm (13.8 in)
	Service <input type="checkbox"/> Repair <input type="checkbox"/> optional <input checked="" type="checkbox"/>

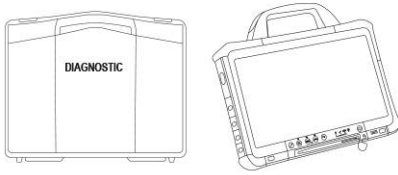
00029296000DE XC_1 NG DE	
 <p>00029296000DE</p>	Description/example of use XC_1 NG as set in German language version with EU safety plug used with model MX1 4 stroke MX2 4 stroke Enduro E1 4 stroke Enduro E2 4 stroke Enduro E3 4 stroke Rally Street
	matching tools / articles are 00029094001 (Scope of supply) 00029094002 (Scope of supply) 00029094003 (Scope of supply) 00029094004 (Scope of supply) 00029094005 (Scope of supply) 00029094006 (Scope of supply) 00029094007 (Scope of supply) 00029094010 (Scope of supply) 00029094011 (Scope of supply) 00029094012 (Scope of supply) 00029094013 (Scope of supply) 00029094015 00029094016 00029094017 (Scope of supply) 00029094019 00029094020

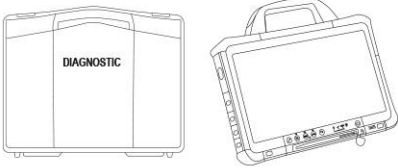

00029296000DE XC_1 NG DE		
		00029094021 (Scope of supply) 00029094022 (Scope of supply) 00029094023 (Scope of supply) 00029094024 (Scope of supply) 00029094025 (Scope of supply) 00029094026 (Scope of supply) 00029094027
	alternative tools 00029296000EN 00029296000ES 00029296000FR 00029296000IT 00029296000JP 00029296000US	
	Service <input checked="" type="checkbox"/>	Repair <input type="checkbox"/>
		optional <input type="checkbox"/>

00029296000EN XC_1 NG EN		
 <p>00029296000EN</p>	Description/example of use XC_1 NG as set in English language version with UK plug	
	used with model MX1 4 stroke MX2 4 stroke Enduro E1 4 stroke Enduro E2 4 stroke Enduro E3 4 stroke Rally Street	matching tools / articles are 00029094001 (Scope of supply) 00029094002 (Scope of supply) 00029094003 (Scope of supply) 00029094004 (Scope of supply) 00029094005 (Scope of supply) 00029094006 (Scope of supply) 00029094008 (Scope of supply) 00029094010 (Scope of supply) 00029094011 (Scope of supply) 00029094012 (Scope of supply) 00029094013 (Scope of supply) 00029094015 00029094016 00029094017 (Scope of supply) 00029094019 00029094020 00029094021 (Scope of supply) 00029094022 (Scope of supply) 00029094023 (Scope of supply) 00029094024 (Scope of supply) 00029094025 (Scope of supply) 00029094026 (Scope of supply) 00029094027
	alternative tools 00029296000DE 00029296000ES 00029296000FR 00029296000IT 00029296000JP 00029296000US	
	Service <input checked="" type="checkbox"/>	Repair <input type="checkbox"/>
		optional <input type="checkbox"/>

00029296000US XC_1 NG US		
 <p>00029296000US</p>	<p>Description/example of use XC_1 NG as set in English language version with US plug</p> <p>used with model</p> <ul style="list-style-type: none"> MX1 4 stroke MX2 4 stroke Enduro E1 4 stroke Enduro E2 4 stroke Enduro E3 4 stroke Rally Street <p>alternative tools</p> <ul style="list-style-type: none"> 00029296000DE 00029296000EN 00029296000ES 00029296000FR 00029296000IT 00029296000JP 	<p>matching tools / articles are</p> <ul style="list-style-type: none"> 00029094001 (Scope of supply) 00029094002 (Scope of supply) 00029094003 (Scope of supply) 00029094004 (Scope of supply) 00029094005 (Scope of supply) 00029094006 (Scope of supply) 00029094009 (Scope of supply) 00029094010 (Scope of supply) 00029094011 (Scope of supply) 00029094012 (Scope of supply) 00029094013 (Scope of supply) 00029094015 00029094016 00029094017 (Scope of supply) 00029094019 00029094020 00029094021 (Scope of supply) 00029094022 (Scope of supply) 00029094023 (Scope of supply) 00029094024 (Scope of supply) 00029094025 (Scope of supply) 00029094026 (Scope of supply) 00029094027
<p>Service <input checked="" type="checkbox"/> Repair <input type="checkbox"/> optional <input type="checkbox"/></p>		

00029296000IT XC_1 NG IT		
 <p>00029296000IT</p>	<p>Description/example of use XC_1 NG as set in Italian language version with EU safety plug</p> <p>used with model</p> <ul style="list-style-type: none"> MX1 4 stroke MX2 4 stroke Enduro E1 4 stroke Enduro E2 4 stroke Enduro E3 4 stroke Rally Street 	<p>matching tools / articles are</p> <ul style="list-style-type: none"> 00029094001 (Scope of supply) 00029094002 (Scope of supply) 00029094003 (Scope of supply) 00029094004 (Scope of supply) 00029094005 (Scope of supply) 00029094006 (Scope of supply) 00029094007 (Scope of supply) 00029094010 (Scope of supply) 00029094011 (Scope of supply) 00029094012 (Scope of supply) 00029094013 (Scope of supply) 00029094015

00029296000IT XC_1 NG IT		
		00029094016 00029094017 (Scope of supply) 00029094019 00029094020 00029094021 (Scope of supply) 00029094022 (Scope of supply) 00029094023 (Scope of supply) 00029094024 (Scope of supply) 00029094025 (Scope of supply) 00029094026 (Scope of supply) 00029094027
	alternative tools 00029296000DE 00029296000EN 00029296000ES 00029296000FR 00029296000JP 00029296000US	
	Service <input checked="" type="checkbox"/>	Repair <input type="checkbox"/>
		optional <input type="checkbox"/>

00029296000FR XC_1 NG FR		
  <p>00029296000FR</p>	<p>Description/example of use</p> <p>XC_1 NG as set in French language version with EU safety plug</p> <p>used with model</p> <p>MX1 4 stroke</p> <p>MX2 4 stroke</p> <p>Enduro E1 4 stroke</p> <p>Enduro E2 4 stroke</p> <p>Enduro E3 4 stroke</p> <p>Rally</p> <p>Street</p>	<p>matching tools / articles are</p> <p>00029094001 (Scope of supply)</p> <p>00029094002 (Scope of supply)</p> <p>00029094003 (Scope of supply)</p> <p>00029094004 (Scope of supply)</p> <p>00029094005 (Scope of supply)</p> <p>00029094006 (Scope of supply)</p> <p>00029094007 (Scope of supply)</p> <p>00029094010 (Scope of supply)</p> <p>00029094011 (Scope of supply)</p> <p>00029094012 (Scope of supply)</p> <p>00029094013 (Scope of supply)</p> <p>00029094015</p> <p>00029094016</p> <p>00029094017 (Scope of supply)</p> <p>00029094019</p> <p>00029094020</p> <p>00029094021 (Scope of supply)</p> <p>00029094022 (Scope of supply)</p> <p>00029094023 (Scope of supply)</p> <p>00029094024 (Scope of supply)</p> <p>00029094025 (Scope of supply)</p> <p>00029094026 (Scope of supply)</p> <p>00029094027</p>
	alternative tools 00029296000DE 00029296000EN 00029296000ES	

00029296000FR XC_1 NG FR			
		00029296000IT 00029296000JP 00029296000US	
Service	<input checked="" type="checkbox"/>	Repair	<input type="checkbox"/>
		optional	<input type="checkbox"/>

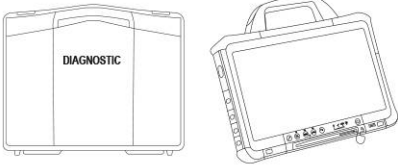
00029296000ES XC_1 NG ES			
 <p>00029296000ES</p>	<p>Description/example of use</p> <p>XC_1 NG as set in Spanish language version with EU safety plug</p>		
	<p>used with model</p> <p>MX1 4 stroke</p> <p>MX2 4 stroke</p> <p>Enduro E1 4 stroke</p> <p>Enduro E2 4 stroke</p> <p>Enduro E3 4 stroke</p> <p>Rally</p> <p>Street</p>	<p>matching tools / articles are</p> <p>00029094001 (Scope of supply)</p> <p>00029094002 (Scope of supply)</p> <p>00029094003 (Scope of supply)</p> <p>00029094004 (Scope of supply)</p> <p>00029094005 (Scope of supply)</p> <p>00029094006 (Scope of supply)</p> <p>00029094007 (Scope of supply)</p> <p>00029094010 (Scope of supply)</p> <p>00029094011 (Scope of supply)</p> <p>00029094012 (Scope of supply)</p> <p>00029094013 (Scope of supply)</p> <p>00029094015</p> <p>00029094016</p> <p>00029094017 (Scope of supply)</p> <p>00029094019</p> <p>00029094020</p> <p>00029094021 (Scope of supply)</p> <p>00029094022 (Scope of supply)</p> <p>00029094023 (Scope of supply)</p> <p>00029094024 (Scope of supply)</p> <p>00029094025 (Scope of supply)</p> <p>00029094026 (Scope of supply)</p> <p>00029094027</p>	
<p>alternative tools</p> <p>00029296000DE</p> <p>00029296000EN</p> <p>00029296000FR</p> <p>00029296000IT</p> <p>00029296000JP</p> <p>00029296000US</p>			
Service	<input checked="" type="checkbox"/>	Repair	<input type="checkbox"/>
		optional	<input type="checkbox"/>

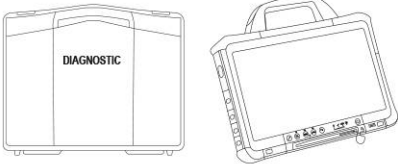
00029296000JP XC_1 NG JP			
 <p>00029296000JP</p>	<p>Description/example of use</p> <p>XC_1 NG as set in Japanese language version with US plug</p>		
	<p>used with model</p> <p>MX1 4 stroke</p> <p>MX2 4 stroke</p> <p>Enduro E1 4 stroke</p> <p>Enduro E2 4 stroke</p> <p>Enduro E3 4 stroke</p> <p>Rally</p>	<p>matching tools / articles are</p> <p>00029094001 (Scope of supply)</p> <p>00029094002 (Scope of supply)</p> <p>00029094003 (Scope of supply)</p> <p>00029094004 (Scope of supply)</p> <p>00029094005 (Scope of supply)</p> <p>00029094006 (Scope of supply)</p>	

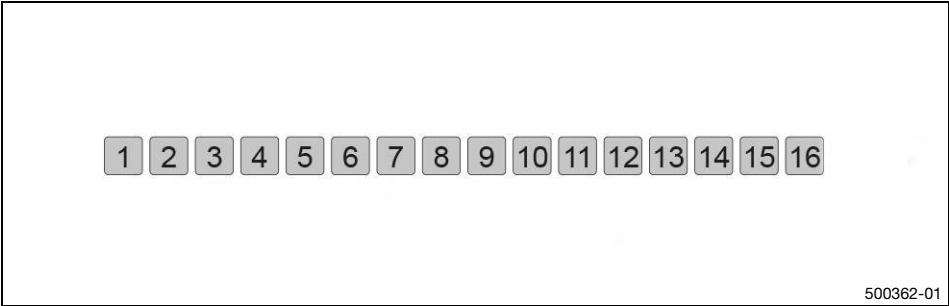

00029296000JP XC_1 NG JP			
	Street	00029094009 (Scope of supply) 00029094010 (Scope of supply) 00029094011 (Scope of supply) 00029094012 (Scope of supply) 00029094013 (Scope of supply) 00029094015 00029094016 00029094017 (Scope of supply) 00029094019 00029094020 00029094021 (Scope of supply) 00029094022 (Scope of supply) 00029094023 (Scope of supply) 00029094024 (Scope of supply) 00029094025 (Scope of supply) 00029094026 (Scope of supply) 00029094027	
	alternative tools 00029296000DE 00029296000EN 00029296000ES 00029296000FR 00029296000IT 00029296000US		
	Service <input checked="" type="checkbox"/>	Repair <input type="checkbox"/>	optional <input type="checkbox"/>

2.1 Overview



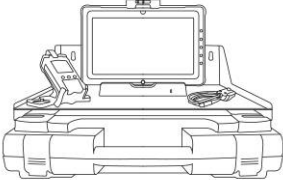

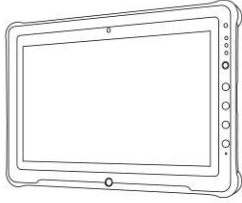
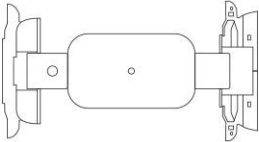
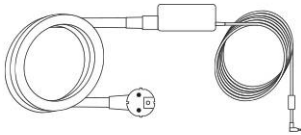

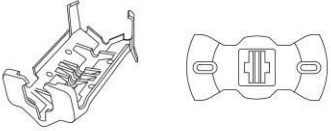
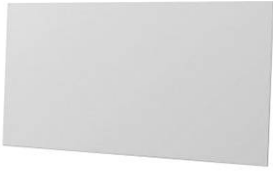
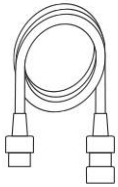

1	XC_2 (00029XC2) (p. 19)
2	Diagnostics tablet (00029XC2001) (p. 20)
3	Hand strap (00029XC2002) (p. 20)
4	Battery charger (00029XC2003) (p. 20)
5	VCI (00029XC2004) (p. 20)
6	VCI attachment (00029XC2005) (p. 21)
7	Protective film (00029XC2006) (p. 21)
8	Diagnostics cable extension (00029XC2007) (p. 21)
9	USB cable (00029XC2008) (p. 22)
10	12 V power supply cable (00029XC2009) (p. 22)
11	RideRecorder trigger (00029XC2010) (p. 22)
12	Case (00029XC2011) (p. 23)
13	Docking station (00029XC2012) (p. 23)
14	Wall attachment (00029XC2013) (p. 23)
15	Battery (00029XC2014) (p. 23)
16	Input stylus (00029XC2015) (p. 24)

00029XC2 XC_2			
 <p>00029XC2</p>	<p>Description/example of use</p> <p>XC_2 professional workshop information and diagnostics system as a set</p> <table border="0" style="width: 100%;"> <tr> <td style="vertical-align: top;"> <p>used with model</p> <p>MX1 4 stroke</p> <p>MX2 4 stroke</p> <p>Enduro E1 4 stroke</p> <p>Enduro E2 4 stroke</p> <p>Enduro E3 4 stroke</p> <p>Rally</p> <p>Street</p> </td> <td style="vertical-align: top;"> <p>matching tools / articles are</p> <p>00029XC2001 (Scope of supply)</p> <p>00029XC2002 (Scope of supply)</p> <p>00029XC2003 (Scope of supply)</p> <p>00029XC2004 (Scope of supply)</p> <p>00029XC2005 (Scope of supply)</p> <p>00029XC2007 (Scope of supply)</p> <p>00029XC2008 (Scope of supply)</p> <p>00029XC2009 (Scope of supply)</p> <p>00029XC2010 (Scope of supply)</p> <p>00029XC2011 (Scope of supply)</p> <p>00029XC2012 (Scope of supply)</p> <p>00029XC2013 (Scope of supply)</p> <p>00029XC2014 (Scope of supply)</p> <p>00029XC2015 (Scope of supply)</p> <p>00029094019</p> </td> </tr> </table>	<p>used with model</p> <p>MX1 4 stroke</p> <p>MX2 4 stroke</p> <p>Enduro E1 4 stroke</p> <p>Enduro E2 4 stroke</p> <p>Enduro E3 4 stroke</p> <p>Rally</p> <p>Street</p>	<p>matching tools / articles are</p> <p>00029XC2001 (Scope of supply)</p> <p>00029XC2002 (Scope of supply)</p> <p>00029XC2003 (Scope of supply)</p> <p>00029XC2004 (Scope of supply)</p> <p>00029XC2005 (Scope of supply)</p> <p>00029XC2007 (Scope of supply)</p> <p>00029XC2008 (Scope of supply)</p> <p>00029XC2009 (Scope of supply)</p> <p>00029XC2010 (Scope of supply)</p> <p>00029XC2011 (Scope of supply)</p> <p>00029XC2012 (Scope of supply)</p> <p>00029XC2013 (Scope of supply)</p> <p>00029XC2014 (Scope of supply)</p> <p>00029XC2015 (Scope of supply)</p> <p>00029094019</p>
<p>used with model</p> <p>MX1 4 stroke</p> <p>MX2 4 stroke</p> <p>Enduro E1 4 stroke</p> <p>Enduro E2 4 stroke</p> <p>Enduro E3 4 stroke</p> <p>Rally</p> <p>Street</p>	<p>matching tools / articles are</p> <p>00029XC2001 (Scope of supply)</p> <p>00029XC2002 (Scope of supply)</p> <p>00029XC2003 (Scope of supply)</p> <p>00029XC2004 (Scope of supply)</p> <p>00029XC2005 (Scope of supply)</p> <p>00029XC2007 (Scope of supply)</p> <p>00029XC2008 (Scope of supply)</p> <p>00029XC2009 (Scope of supply)</p> <p>00029XC2010 (Scope of supply)</p> <p>00029XC2011 (Scope of supply)</p> <p>00029XC2012 (Scope of supply)</p> <p>00029XC2013 (Scope of supply)</p> <p>00029XC2014 (Scope of supply)</p> <p>00029XC2015 (Scope of supply)</p> <p>00029094019</p>		
Service <input checked="" type="checkbox"/>	Repair <input type="checkbox"/> optional <input type="checkbox"/>		

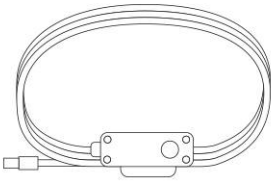
00029XC2001 Diagnostics tablet	
 <p>00029XC2001</p>	<p>Description/example of use</p> <p>Getac F110 diagnostics tablet with software for vehicle diagnostics for use with 00029XC2</p> <p>used with model</p> <p>MX1 4 stroke MX2 4 stroke Enduro E1 4 stroke Enduro E2 4 stroke Enduro E3 4 stroke Rally Street</p>
Spare parts	
00029XC2002 Hand strap	
 <p>00029XC2002</p>	<p>Description/example of use</p> <p>Handle for diagnostics tablet for use with 00029XC2</p> <p>used with model</p> <p>MX1 4 stroke MX2 4 stroke Enduro E1 4 stroke Enduro E2 4 stroke Enduro E3 4 stroke Rally Street</p>
Spare parts	
00029XC2003 Battery charger	
 <p>00029XC2003</p>	<p>Description/example of use</p> <p>Battery charger and power supply unit for Getac F110 diagnostics tablet for use with 00029XC2</p> <p>used with model</p> <p>MX1 4 stroke MX2 4 stroke Enduro E1 4 stroke Enduro E2 4 stroke Enduro E3 4 stroke Rally Street</p>
Spare parts	
00029XC2004 VCI	
 <p>00029XC2004</p>	<p>Description/example of use</p> <p>The Vehicle Communication Interface (VCI) is connected to the diagnostic connector of the vehicle and the diagnostics tablet for use with 00029XC2</p> <p>used with model</p> <p>MX1 4 stroke MX2 4 stroke Enduro E1 4 stroke</p>

00029XC2004 VCI	
	Enduro E2 4 stroke Enduro E3 4 stroke Rally Street Spare parts
00029XC2005 VCI attachment	
 <p>00029XC2005</p>	Description/example of use Attachment for the VCI incl. attachment for the fuel tank for use with 00029XC2 used with model MX1 4 stroke MX2 4 stroke Enduro E1 4 stroke Enduro E2 4 stroke Enduro E3 4 stroke Rally Street Spare parts
00029XC2006 Protective film	
 <p>00029XC2006</p>	Description/example of use Protective film for the touchscreen of the Getac F110 diagnostics tablet Service <input type="checkbox"/> Repair <input type="checkbox"/> optional <input checked="" type="checkbox"/>
00029XC2007 Diagnostics cable extension	
 <p>00029XC2007</p>	Description/example of use Extension cables between VCI and diagnostic connector on the vehicle Technical data Length approx.: 1.15 m (3.77 ft) for use with 00029XC2 used with model MX1 4 stroke MX2 4 stroke Enduro E1 4 stroke Enduro E2 4 stroke Enduro E3 4 stroke Rally Street Spare parts

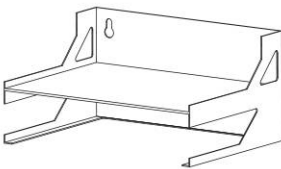
00029XC2008 USB cable	
 <p>00029XC2008</p>	<p>Description/example of use</p> <p>USB cable type A to ODU MINI-SNAP Series L (diagnostics tablet to VCI)</p> <p>Technical data for use with</p> <p>Length approx.: 5 m (16 ft) 00029XC2</p> <p>used with model</p> <p>MX1 4 stroke</p> <p>MX2 4 stroke</p> <p>Enduro E1 4 stroke</p> <p>Enduro E2 4 stroke</p> <p>Enduro E3 4 stroke</p> <p>Rally</p> <p>Street</p>
Spare parts	
00029XC2009 12 V power supply cable	
 <p>00029XC2009</p>	<p>Description/example of use</p> <p>External power supply for the VCI for vehicles without battery and for flashing of specific control units</p> <p>for use with</p> <p>00029XC2</p> <p>used with model</p> <p>MX1 4 stroke</p> <p>MX2 4 stroke</p> <p>Enduro E1 4 stroke</p> <p>Enduro E2 4 stroke</p> <p>Enduro E3 4 stroke</p> <p>Rally</p> <p>Street</p>
Spare parts	
00029XC2010 RideRecorder trigger	
 <p>00029XC2010</p>	<p>Description/example of use</p> <p>Tip switch for triggering a marker while recording measurement data</p> <p>for use with</p> <p>00029XC2</p> <p>used with model</p> <p>MX1 4 stroke</p> <p>MX2 4 stroke</p> <p>Enduro E1 4 stroke</p> <p>Enduro E2 4 stroke</p> <p>Enduro E3 4 stroke</p> <p>Rally</p> <p>Street</p>
Spare parts	

00029XC2011 Case	
 <p>00029XC2011</p>	<p>Description/example of use</p> <p>Case including inlay for storing the VCI and all cables and adapters for diagnosis for use with 00029XC2</p> <p>used with model</p> <p>MX1 4 stroke MX2 4 stroke Enduro E1 4 stroke Enduro E2 4 stroke Enduro E3 4 stroke Rally Street</p>
Spare parts	
00029XC2012 Docking station	
 <p>00029XC2012</p>	<p>Description/example of use</p> <p>Docking station for the Getac F110 diagnostics tablet for use with 00029XC2</p>
Spare parts	
00029XC2013 Wall attachment	
 <p>00029XC2013</p>	<p>Description/example of use</p> <p>Device for securing on the wall for use with 00029XC2</p>
Spare parts	
00029XC2014 Battery	
 <p>00029XC2014</p>	<p>Description/example of use</p> <p>Battery for the Getac F110 diagnostics tablet for use with 00029XC2</p> <p>used with model</p> <p>MX1 4 stroke MX2 4 stroke Enduro E1 4 stroke Enduro E2 4 stroke Enduro E3 4 stroke Rally Street</p>
Spare parts	

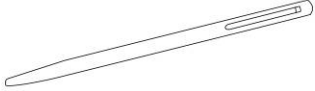
00029XC2015 Input stylus	
 <p>00029XC2015</p>	<p>Description/example of use</p> <p>Stylus for input via the touch screen of the Getac F110 diagnostics tablet for use with 00029XC2</p> <p>used with model</p> <p>MX1 4 stroke MX2 4 stroke Enduro E1 4 stroke Enduro E2 4 stroke Enduro E3 4 stroke Rally Street</p>
Spare parts	

3.1 Overview

- 1 2 3 4 5 6 7 8 9 10

H01823-01

- | | |
|----|--|
| 1 | Break out box (00029095001) (📖 p. 25) |
| 2 | Adapter and template EFI (00029095003) (📖 p. 25) |
| 3 | Adapter and template KHRS (00029095010) (📖 p. 26) |
| 4 | Adapter and template KHR4 (00029095011) (📖 p. 26) |
| 5 | Adapter and template KRSZ (00029095012) (📖 p. 26) |
| 6 | Adapter and template M3C (00029095013) (📖 p. 27) |
| 7 | EU battery charger XCharge-professional (00029095050) (📖 p. 27) |
| 8 | US battery charger XCharge-professional (00029095051) (📖 p. 28) |
| 9 | UK battery charger XCharge-professional (00029095052) (📖 p. 28) |
| 10 | CH battery charger XCharge-professional (00029095053) (📖 p. 29) |

00029095001 Break out box



00029095001

Description/example of use

Box with connector board (without adapter and templates) for carrying out various electrical measurements on the vehicle wiring harness

used with model

MX1 4 stroke
 MX2 4 stroke
 Enduro E1 4 stroke
 TE 250i EU 2018
 TE 250i US 2018
 Enduro E2 4 stroke
 TE 300i EU 2018
 Enduro E3 4 stroke
 Rally
 Cross Country E2
 Supermoto
 Street Enduro
 Naked Mid

Spare parts

00029095003 Adapter and template EFI





00029095003

Description/example of use

Adapter cable and template for performing various electrical measurements on the vehicle wiring harness

used with model

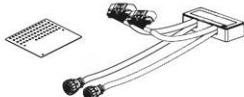
FC 350 2014
 FC 350 2015
 FC 450 2014
 FC 450 2015
 FC 250 2014

00029095003 Adapter and template EFI	
	FC 250 2015 FE 350 2014 FE 350 2015 FE 350 2016 FE 450 2014 FE 450 2015 FE 450 2016 FE 501 2014 FE 501 2015 FE 501 2016 FE 501 S 2015 FE 501 S 2016 FS 450 2015
	Spare parts
00029095010 Adapter and template KHRS	
 <p>00029095010</p>	Description/example of use Adapter cable and template for performing various electrical measurements on the vehicle wiring harness
	used with model 701 Supermoto 2016 701 Enduro 2016
	Spare parts
00029095011 Adapter and template KHR4	
 <p>00029095011</p>	Description/example of use Adapter cable and template for performing various electrical measurements on the vehicle wiring harness
	used with model 701 Supermoto 2017 701 Supermoto 2018 701 Enduro 2017 701 Enduro 2018 Naked Mid
	Spare parts
00029095012 Adapter and template KRSZ	
 <p>00029095012</p>	Description/example of use Adapter cable and template for performing various electrical measurements on the vehicle wiring harness
	used with model FC 350 2016 FC 350 2017 FC 350 2018 FC 450 2016 FC 450 2017 FC 450 2018 FC 250 2016 FC 250 2017 FC 250 2018

00029095012 Adapter and template KRSZ	
 <p>00029095013</p>	Enduro E1 4 stroke
	FE 350 2017
	FE 350 2018
	FE 350 S 2017
	FE 350 S 2018
	FE 450 2017
	FE 450 2018
	FE 501 2017
	FE 501 2018
	FE 501 S 2017
	FE 501 S 2018
	Rally
	Cross Country E2
FS 450 2016	
FS 450 2017	
FS 450 2018	
Spare parts	

00029095013 Adapter and template M3C	
 <p>00029095013</p>	<i>Description/example of use</i>
	Adapter cable and template for performing various electrical measurements on the vehicle wiring harness
	<i>used with model</i>
	TE 250i EU 2018
	TE 250i US 2018
TE 300i EU 2018	
Spare parts	

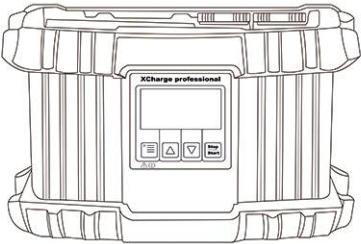
00029095050 EU battery charger XCharge-professional	
	<i>Description/example of use</i>
	Specially designed battery charger for the correct charging of various 12 V batteries (acid, AGM and lithium-ion), backup operation with diagnosis and flash operations, refresh function at deep discharge, initial charge for the activation of dry batteries, the software can be updated using a dongle
	<i>Technical data</i>
	EU safety plug
	Nominal voltage: 230 V
	Mains fuse: 16 A
	Power cable length approx.: 5 m (16 ft)
	Charger cable length approx.: 5 m (16 ft)
	<i>used with model</i>
	MX1 4 stroke
	MX2 4 stroke
	TE 150
	Enduro E1 4 stroke
	Enduro E2
	Enduro E3
Rally	
Cross Country E3	
Street	
alternative tools	

00029095050 EU battery charger XCharge-professional			
	00029095051		
	00029095052		
	00029095053		
Service	<input checked="" type="checkbox"/>	Repair	<input type="checkbox"/>
		optional	<input type="checkbox"/>

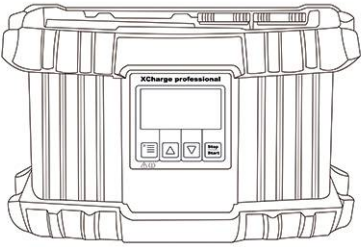
00029095051 US battery charger XCharge-professional			
	<p>Description/example of use</p> <p>Specially designed battery charger for the correct charging of various 12 V batteries (acid, AGM and lithium-ion), backup operation with diagnosis and flash operations, refresh function at deep discharge, initial charge for the activation of dry batteries, the software can be updated using a dongle</p> <p>Technical data</p> <p>US plug</p> <p>Nominal voltage: 120 V</p> <p>Mains fuse: 32 A</p> <p>Power cable length approx.: 5 m (16 ft)</p> <p>Charger cable length approx.: 5 m (16 ft)</p> <p>used with model</p> <p>MX1 4 stroke</p> <p>MX2 4 stroke</p> <p>TE 150</p> <p>Enduro E1 4 stroke</p> <p>Enduro E2</p> <p>Enduro E3</p> <p>Rally</p> <p>Cross Country E3</p> <p>Street</p> <p>alternative tools</p> <p>00029095050</p> <p>00029095052</p> <p>00029095053</p>		
	Service	<input checked="" type="checkbox"/>	Repair
		optional	<input type="checkbox"/>

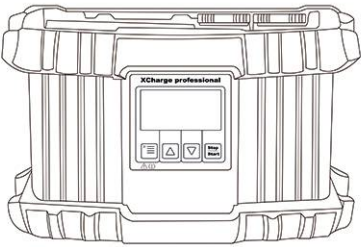
00029095052 UK battery charger XCharge-professional			
	<p>Description/example of use</p> <p>Specially designed battery charger for the correct charging of various 12 V batteries (acid, AGM and lithium-ion), backup operation with diagnosis and flash operations, refresh function at deep discharge, initial charge for the activation of dry batteries, the software can be updated using a dongle</p> <p>Technical data</p> <p>UK safety plug</p> <p>Nominal voltage: 230 V</p> <p>Mains fuse: 16 A</p> <p>Power cable length approx.: 5 m (16 ft)</p> <p>Charger cable length approx.: 5 m (16 ft)</p> <p>used with model</p> <p>MX1 4 stroke</p> <p>MX2 4 stroke</p> <p>TE 150</p> <p>Enduro E1 4 stroke</p> <p>Enduro E2</p> <p>Enduro E3</p> <p>Rally</p> <p>Cross Country E3</p>		
	Service	<input checked="" type="checkbox"/>	Repair
		optional	<input type="checkbox"/>

00029095052 UK battery charger XCharge-professional			
	Street		
	alternative tools		
	00029095050		
			00029095051
			00029095053
Service	<input checked="" type="checkbox"/>	Repair	<input type="checkbox"/>
		optional	<input type="checkbox"/>

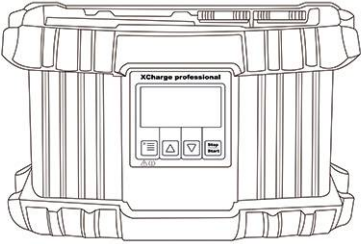
00029095053 CH battery charger XCharge-professional			
	Description/example of use		
	Specially designed battery charger for the correct charging of various 12 V batteries (acid, AGM and lithium-ion), backup operation with diagnosis and flash operations, refresh function at deep discharge, initial charge for the activation of dry batteries, the software can be updated using a dongle		
	Technical data		
	CH plug		
	Nominal voltage: 230 V		
	Mains fuse: 16 A		
	Power cable length approx.: 5 m (16 ft)		
	Charger cable length approx.: 5 m (16 ft)		
	used with model		
	MX1 4 stroke		
	MX2 4 stroke		
	TE 150		
	Enduro E1 4 stroke		
	Enduro E2		
	Enduro E3		
Rally			
Cross Country E3			
Street			
alternative tools			
00029095050			
00029095051			
00029095052			
Service	<input checked="" type="checkbox"/>	Repair	<input type="checkbox"/>
		optional	<input type="checkbox"/>

3.2 Wall tool organizer overview

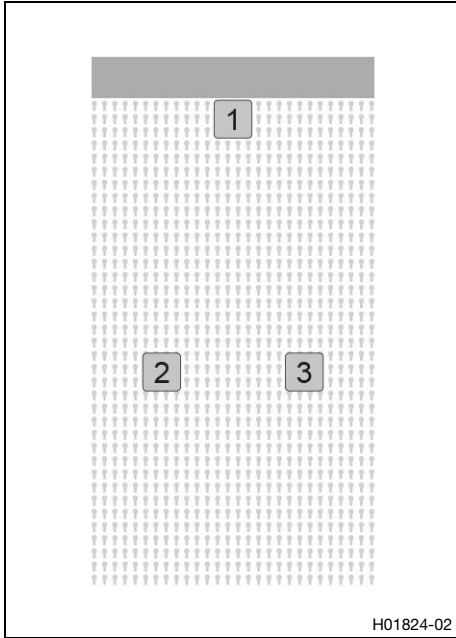

1	Cable connector unlocking kit (00029014000) (📖 p. 30)
2	Tachometer (45129075000) (📖 p. 30)
3	Peak voltage adapter (58429042000) (📖 p. 30)

00029014000 Cable connector unlocking kit

<p style="text-align: center;">00029014000</p>	Description/example of use Pinout kit including case and crimping pliers for repairing wiring harnesses or replacing the most common connectors				
	used with model Husqvarna				
Service	<input type="checkbox"/>	Repair	<input type="checkbox"/>	optional	<input checked="" type="checkbox"/>

45129075000 Tachometer

<p style="text-align: center;">45129075000</p>	Description/example of use Measuring device for checking idle speed				
	used with model Offroad Supermoto Competition				
Service	<input checked="" type="checkbox"/>	Repair	<input type="checkbox"/>	optional	<input type="checkbox"/>

58429042000 Peak voltage adapter

<p style="text-align: center;">58429042000</p>	Description/example of use Tool for connection to a commercially available multimeter, for checking ignition components				
	used with model Mini MX1 2 stroke MX2 2 stroke Enduro E1 2 stroke Enduro E2 2 stroke Enduro E3 2 stroke Cross Country E3				
Service	<input checked="" type="checkbox"/>	Repair	<input type="checkbox"/>	optional	<input type="checkbox"/>

4.1 Overview

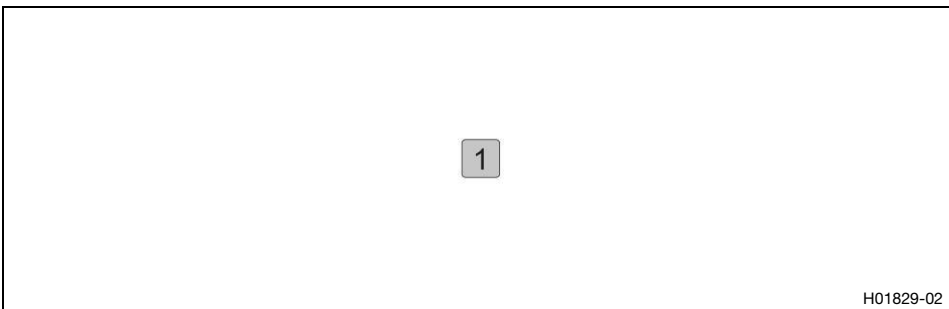

H01829-02

1 Bleeding device (00029013100) (📖 p. 31)

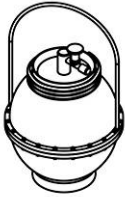
00029013100 Bleeding device		
 00029013100	Description/example of use Tool for servicing hydraulic brake systems	
	used with model Husqvarna	matching tools / articles are 00029013002 00029013004 00029013005 00029013006 00029013009 00029013012 00029013013 00029013014 00029013015 00029013018 00029013019 00029013020 00029013023
Service <input checked="" type="checkbox"/>	Repair <input type="checkbox"/>	optional <input type="checkbox"/>

4.2 Wall tool organizer overview

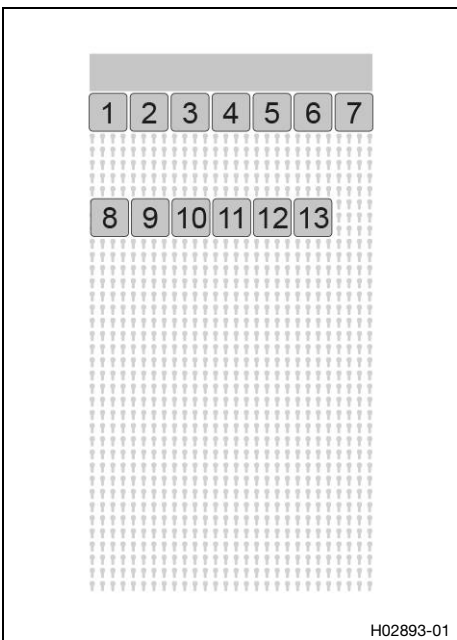

H02893-01

1	Bleeder cover (00029013002) (📖 p. 32)
2	Bleeder cover (00029013004) (📖 p. 32)
3	Bleeder cover (00029013005) (📖 p. 32)
4	Bleeder cover (00029013006) (📖 p. 33)
5	Bleeder cover (00029013009) (📖 p. 33)
6	Bleeder cover (00029013012) (📖 p. 33)
7	Bleeder cover (00029013013) (📖 p. 34)
8	Bleeder cover (00029013014) (📖 p. 34)
9	Bleeder cover (00029013015) (📖 p. 34)
10	Bleeder cover (00029013018) (📖 p. 34)
11	Bleeder cover (00029013019) (📖 p. 34)
12	Bleeder cover (00029013020) (📖 p. 35)
13	Bleeder cover (00029013023) (📖 p. 35)

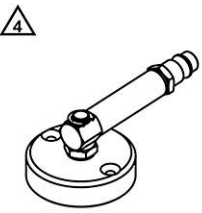
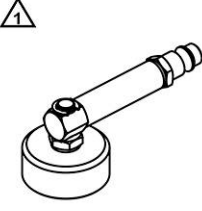
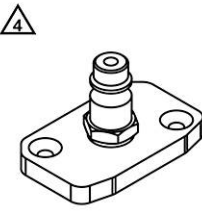
00029013002 Bleeder cover					
 <p>00029013002</p>	Description/example of use Adapter for hand or foot brake cylinder, for filling or bleeding the brake system for use with 00029013100 used with model Supermoto Competition				
	Service	<input checked="" type="checkbox"/>	Repair	<input type="checkbox"/>	optional
00029013004 Bleeder cover					
 <p>00029013004</p>	Description/example of use Adapter for hand or foot brake cylinder, for filling or bleeding the brake system for use with 00029013100 used with model Rally Supermoto / Dual Sport Street Enduro Naked Mid				
	Service	<input checked="" type="checkbox"/>	Repair	<input type="checkbox"/>	optional
00029013005 Bleeder cover					
 <p>00029013005</p>	Description/example of use Adapter for hand or foot brake cylinder, for filling or bleeding the brake system for use with 00029013100 used with model MX TE 125 TE 150 2017 TX 125 2017 Enduro E1 4 stroke TE 250 2014 TE 250 2015 TE 250 2016 TE 250 2017 Enduro E2 4 stroke TE 300 2014 TE 300 2015 TE 300 2016 TE 300 2017 Enduro E3 4 stroke Rally Cross Country				
	Service	<input checked="" type="checkbox"/>	Repair	<input type="checkbox"/>	optional

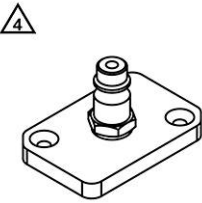
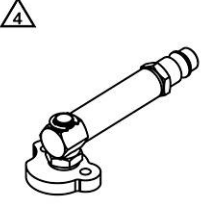
00029013006 Bleeder cover			
 <p>00029013006</p>	Description/example of use Adapter for hand or foot brake cylinder, for filling or bleeding the brake system for use with 00029013100		
	used with model MX TE 125 TE 150 2017 TX 125 2017 Enduro E1 4 stroke TE 250 2014 TE 250 2015 TE 250 2016 TE 250 2017 Enduro E2 4 stroke TE 300 2014 TE 300 2015 TE 300 2016 TE 300 2017 Enduro E3 4 stroke Rally Cross Country Supermoto Competition		
	Service	<input checked="" type="checkbox"/>	Repair
			<input type="checkbox"/>
	optional		<input type="checkbox"/>
00029013009 Bleeder cover			
 <p>00029013009</p>	Description/example of use Adapter for hand or foot brake cylinder, for filling or bleeding the brake system for use with 00029013100		
	used with model Naked Small		
	Service	<input checked="" type="checkbox"/>	Repair
			<input type="checkbox"/>
	optional		<input type="checkbox"/>
00029013012 Bleeder cover			
 <p>00029013012</p>	Description/example of use Adapter for hand or foot brake cylinder, for filling or bleeding the brake system for use with 00029013100		
	used with model Mini		
	Service	<input checked="" type="checkbox"/>	Repair
			<input type="checkbox"/>
	optional		<input type="checkbox"/>

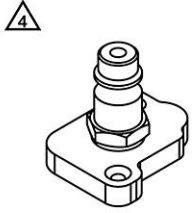
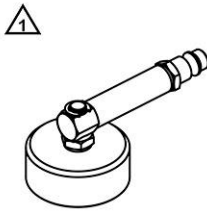
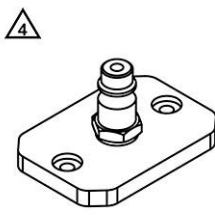
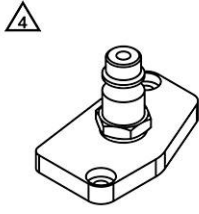
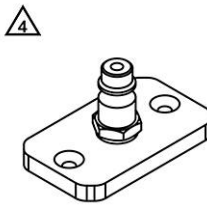
00029013013 Bleeder cover			
 <p>00029013013</p>	Description/example of use Adapter for hand or foot brake cylinder, for filling or bleeding the brake system for use with 00029013100 used with model TC 50		
	Service	<input checked="" type="checkbox"/>	Repair
optional	<input type="checkbox"/>		
00029013014 Bleeder cover			
 <p>00029013014</p>	Description/example of use Adapter for hand or foot brake cylinder, for filling or bleeding the brake system for use with 00029013100 used with model Naked Small		
	Service	<input checked="" type="checkbox"/>	Repair
optional	<input type="checkbox"/>		
00029013015 Bleeder cover			
 <p>00029013015</p>	Description/example of use Adapter for hand or foot brake cylinder, for filling or bleeding the brake system for use with 00029013100 used with model Supermoto / Dual Sport Street Enduro		
	Service	<input checked="" type="checkbox"/>	Repair
optional	<input type="checkbox"/>		
00029013018 Bleeder cover			
 <p>00029013018</p>	Description/example of use Adapter for hand or foot brake cylinder, for filling or bleeding the brake system for use with 00029013100 used with model TC 65 TC 85		
	Service	<input checked="" type="checkbox"/>	Repair
optional	<input type="checkbox"/>		
00029013019 Bleeder cover			
 <p>00029013019</p>	Description/example of use Adapter for hand or foot brake cylinder, for filling or bleeding the brake system for use with 00029013100 used with model TC 250 2018 FC 350 2018 FC 450 2018 TC 125 2018 FC 250 2018 TE 150 2018 TX 125 2018		

00029013019 Bleeder cover		
	FE 250 2018	
	TE 250 2018	
	FE 350 2018	
	FE 350 S 2018	
	FE 450 2018	
	TE 300 2018	
	FE 501 2018	
	FE 501 S 2018	
	FX 450 2018	
	TX 300 2018	
Service	<input checked="" type="checkbox"/>	Repair <input type="checkbox"/> optional <input type="checkbox"/>

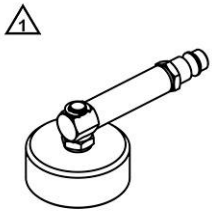
00029013020 Bleeder cover		
 <p>00029013020</p>	Description/example of use	
	Adapter for hand or foot brake cylinder, for filling or bleeding the brake system	
	for use with 00029013100	
	used with model	
	TC 250 2018	
	FC 350 2018	
	FC 450 2018	
	TC 125 2018	
	FC 250 2018	
	TE 150 2018	
TX 125 2018		
FE 250 2018		
TE 250 2018		
FE 350 2018		
FE 350 S 2018		
FE 450 2018		
TE 300 2018		
FE 501 2018		
FE 501 S 2018		
FX 450 2018		
TX 300 2018		
Service	<input checked="" type="checkbox"/>	Repair <input type="checkbox"/> optional <input type="checkbox"/>

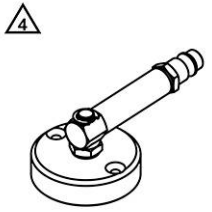
00029013023 Bleeder cover		
 <p>00029013023</p>	Description/example of use	
	Adapter for hand or foot brake cylinder, for filling or bleeding the brake system	
	for use with 00029013100	
	used with model	
	Naked Mid	
Service	<input checked="" type="checkbox"/>	Repair <input type="checkbox"/> optional <input type="checkbox"/>

5.1 Overview

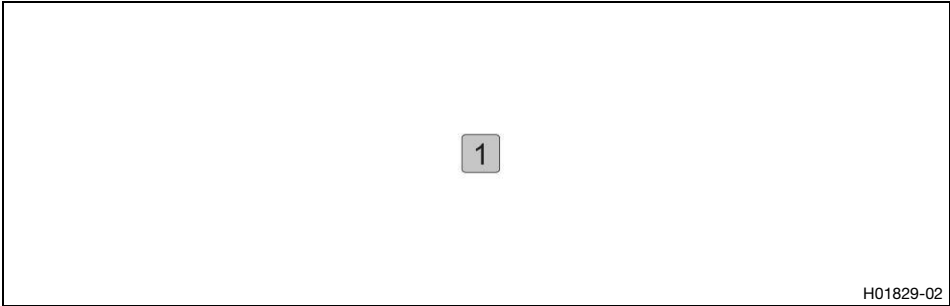

1 Engine assembly stand (80329001000) (📖 p. 36)

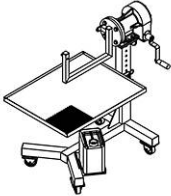
80329001000 Engine assembly stand		
 <p>80329001000</p>	<p>Description/example of use</p> <p>Tool (incl. chassis, crank rotation mechanism, oil pan and engine bracket) for mounting the removed engine</p>	
	<p>used with model</p> <p>Mini</p> <p>MX</p> <p>Enduro E1</p> <p>Enduro E2</p> <p>Enduro E3</p> <p>Cross Country</p> <p>Street</p>	<p>matching tools / articles are</p> <p>45229001060</p> <p>45229001070</p> <p>46229001060</p> <p>46229001070</p> <p>47229002020</p> <p>50429002020</p> <p>55429002000</p> <p>56029002000</p> <p>56029002020</p> <p>56029002030</p> <p>75012001060</p> <p>75012001070</p> <p>77229002000</p> <p>78029002000</p> <p>79229002000</p> <p>79429002000</p> <p>90129002000</p>
<p>Service <input type="checkbox"/></p>	<p>Repair <input checked="" type="checkbox"/></p>	<p>optional <input type="checkbox"/></p>

5.2 Wall tool organizer overview

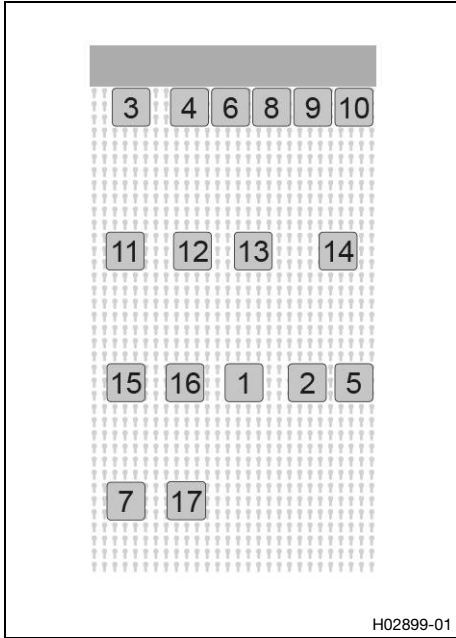

1	Fitting for work stand (45229001060) (📖 p. 37)
2	Holder for engine motor stand (45229001070) (📖 p. 37)
3	Fitting for work stand (46229001060) (📖 p. 37)
4	Holder for engine motor stand (46229001070) (📖 p. 38)
5	Holder for engine motor stand (47229002020) (📖 p. 38)
6	Holder for engine motor stand (50429002020) (📖 p. 38)
7	Holder and fitting for work stand (55429002000) (📖 p. 38)
8	Holder for engine motor stand (56029002000) (📖 p. 39)
9	Holder for engine motor stand (56029002020) (📖 p. 39)
10	Holder for engine motor stand (56029002030) (📖 p. 39)
11	Fitting for work stand (75012001060) (📖 p. 39)
12	Holder for engine motor stand (75012001070) (📖 p. 40)
13	Holder and fitting for work stand (77229002000) (📖 p. 40)
14	Holder and fitting for work stand (78029002000) (📖 p. 40)
15	Holder and fitting for work stand (79229002000) (📖 p. 41)
16	Holder and fitting for work stand (79429002000) (📖 p. 41)
17	Holder and fitting for work stand (90129002000) (📖 p. 41)

45229001060 Fitting for work stand					
<p>3x 1</p> <p>45229001060</p>	Description/example of use Tool for securing the removed engine on the engine assembly stand for use with 80329001000 used with model TC 50				
	Service	<input type="checkbox"/>	Repair	<input checked="" type="checkbox"/>	optional

45229001070 Holder for engine motor stand					
<p>45229001070</p>	Description/example of use Tool for securing the removed engine on the engine assembly stand for use with 80329001000 used with model TC 50				
	Service	<input type="checkbox"/>	Repair	<input checked="" type="checkbox"/>	optional

46229001060 Fitting for work stand					
<p>3x 1</p> <p>46229001060</p>	Description/example of use Tool for securing the removed engine on the engine assembly stand for use with 80329001000 used with model TC 65 TC 85 2014 TC 85 2015 TC 85 2016 TC 85 2017				
	Service	<input type="checkbox"/>	Repair	<input checked="" type="checkbox"/>	optional

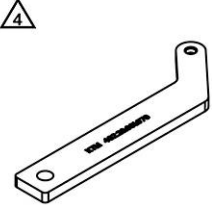
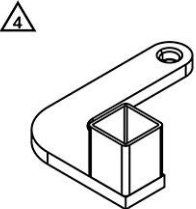
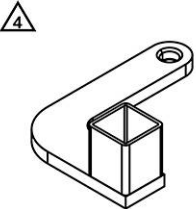
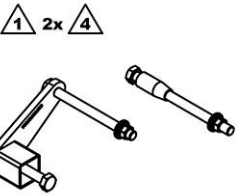
46229001070 Holder for engine motor stand								
 <p>46229001070</p>	<p>Description/example of use Tool for securing the removed engine on the engine assembly stand for use with 80329001000</p> <p>used with model TC 65 TC 85 2014 TC 85 2015 TC 85 2016 TC 85 2017</p> <table border="1" data-bbox="568 573 1501 613"> <tr> <td>Service</td> <td><input type="checkbox"/></td> <td>Repair</td> <td><input checked="" type="checkbox"/></td> <td>optional</td> <td><input type="checkbox"/></td> </tr> </table>		Service	<input type="checkbox"/>	Repair	<input checked="" type="checkbox"/>	optional	<input type="checkbox"/>
Service	<input type="checkbox"/>	Repair	<input checked="" type="checkbox"/>	optional	<input type="checkbox"/>			
47229002020 Holder for engine motor stand								
 <p>47229002020</p>	<p>Description/example of use Tool for securing the removed engine on the engine assembly stand for use with 80329001000</p> <p>used with model TC 85 2018</p> <table border="1" data-bbox="568 947 1501 987"> <tr> <td>Service</td> <td><input type="checkbox"/></td> <td>Repair</td> <td><input checked="" type="checkbox"/></td> <td>optional</td> <td><input type="checkbox"/></td> </tr> </table>		Service	<input type="checkbox"/>	Repair	<input checked="" type="checkbox"/>	optional	<input type="checkbox"/>
Service	<input type="checkbox"/>	Repair	<input checked="" type="checkbox"/>	optional	<input type="checkbox"/>			
50429002020 Holder for engine motor stand								
 <p>50429002020</p>	<p>Description/example of use Tool for securing the removed engine on the engine assembly stand for use with 80329001000</p> <p>used with model TC 125 2016 TC 125 2017 TC 125 2018 TE 150 TX 125</p> <table border="1" data-bbox="568 1413 1501 1453"> <tr> <td>Service</td> <td><input type="checkbox"/></td> <td>Repair</td> <td><input checked="" type="checkbox"/></td> <td>optional</td> <td><input type="checkbox"/></td> </tr> </table>		Service	<input type="checkbox"/>	Repair	<input checked="" type="checkbox"/>	optional	<input type="checkbox"/>
Service	<input type="checkbox"/>	Repair	<input checked="" type="checkbox"/>	optional	<input type="checkbox"/>			
55429002000 Holder and fitting for work stand								
 <p>55429002000</p>	<p>Description/example of use Tool for securing the removed engine on the engine assembly stand for use with 80329001000</p> <p>used with model TC 250 2017 TC 250 2018 TE 250 2017 TE 250 2018 TE 300 2017 TE 300 2018 Cross Country E3</p> <table border="1" data-bbox="568 1955 1501 1995"> <tr> <td>Service</td> <td><input type="checkbox"/></td> <td>Repair</td> <td><input checked="" type="checkbox"/></td> <td>optional</td> <td><input type="checkbox"/></td> </tr> </table>		Service	<input type="checkbox"/>	Repair	<input checked="" type="checkbox"/>	optional	<input type="checkbox"/>
Service	<input type="checkbox"/>	Repair	<input checked="" type="checkbox"/>	optional	<input type="checkbox"/>			

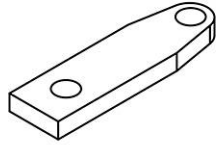
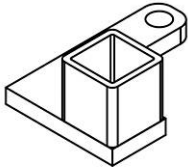
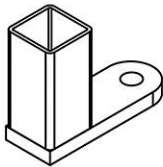
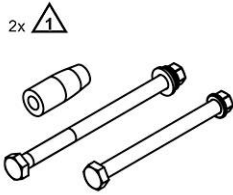
56029002000 Holder for engine motor stand					
 <p>56029002000</p>	Description/example of use Tool for securing the removed engine on the engine assembly stand for use with 80329001000 used with model TC 125 2014 TC 125 2015 TE 125				
	Service	<input type="checkbox"/>	Repair	<input checked="" type="checkbox"/>	optional
56029002020 Holder for engine motor stand					
 <p>56029002020</p>	Description/example of use Tool for securing the removed engine on the engine assembly stand for use with 80329001000 used with model TC 125 2014 TC 125 2015 TE 125				
	Service	<input type="checkbox"/>	Repair	<input checked="" type="checkbox"/>	optional
56029002030 Holder for engine motor stand					
 <p>56029002030</p>	Description/example of use Tool for securing the removed engine on the engine assembly stand for use with 80329001000 used with model TC 250 2014 TC 250 2015 TC 250 2016 TE 250 2014 TE 250 2015 TE 250 2016 TE 300 2014 TE 300 2015 TE 300 2016				
	Service	<input type="checkbox"/>	Repair	<input checked="" type="checkbox"/>	optional
75012001060 Fitting for work stand					
 <p>75012001060</p>	Description/example of use Tool for securing the removed engine on the engine assembly stand for use with 80329001000 used with model Supermoto / Dual Sport Street Enduro Naked Mid				
	Service	<input type="checkbox"/>	Repair	<input checked="" type="checkbox"/>	optional

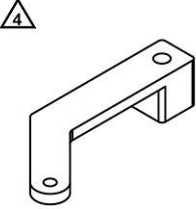
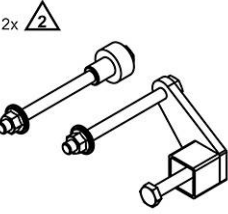
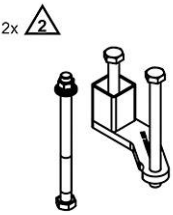
75012001070 Holder for engine motor stand		
 <p>75012001070</p>	<p>Description/example of use</p> <p>Tool for securing the removed engine on the engine assembly stand</p> <p>for use with</p> <p>80329001000</p> <p>used with model</p> <p>Supermoto / Dual Sport</p> <p>Street Enduro</p> <p>Naked Mid</p>	<p>Service <input type="checkbox"/></p> <p>Repair <input checked="" type="checkbox"/></p> <p>optional <input type="checkbox"/></p>
77229002000 Holder and fitting for work stand		
 <p>77229002000</p>	<p>Description/example of use</p> <p>Tool for securing the removed engine on the engine assembly stand</p> <p>for use with</p> <p>80329001000</p> <p>used with model</p> <p>FC 350 2014</p> <p>FC 350 2015</p> <p>FC 250 2014</p> <p>FC 250 2015</p> <p>FE 250 2014</p> <p>FE 250 2015</p> <p>FE 250 2016</p> <p>FE 350 2014</p> <p>FE 350 2015</p> <p>FE 350 2016</p> <p>FE 350 S 2015</p> <p>FE 350 S 2016</p>	<p>Service <input type="checkbox"/></p> <p>Repair <input checked="" type="checkbox"/></p> <p>optional <input type="checkbox"/></p>
78029002000 Holder and fitting for work stand		
 <p>78029002000</p>	<p>Description/example of use</p> <p>Tool for securing the removed engine on the engine assembly stand</p> <p>for use with</p> <p>80329001000</p> <p>used with model</p> <p>FC 450 2014</p> <p>FC 450 2015</p> <p>FE 450 2014</p> <p>FE 450 2015</p> <p>FE 450 2016</p> <p>FE 501 2014</p> <p>FE 501 2015</p> <p>FE 501 2016</p> <p>FE 501 S 2015</p> <p>FE 501 S 2016</p> <p>FS 450 2015</p>	<p>Service <input type="checkbox"/></p> <p>Repair <input checked="" type="checkbox"/></p> <p>optional <input type="checkbox"/></p>

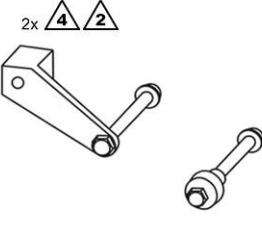
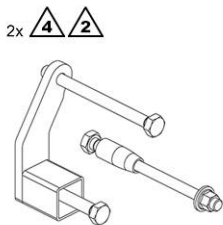
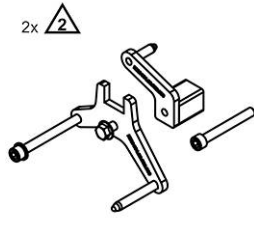
79229002000 Holder and fitting for work stand								
 <p>79229002000</p>	<p>Description/example of use</p> <p>Tool for securing the removed engine on the engine assembly stand for use with 80329001000</p> <p>used with model</p> <p>FC 350 2016 FC 350 2017 FC 350 2018 FC 250 2016 FC 250 2017 FC 250 2018 FE 250 2017 FE 250 2018 FE 350 2017 FE 350 2018 FE 350 S 2017 FE 350 S 2018 FX 350</p>	<table border="1" style="width: 100%; border-collapse: collapse;"> <tr> <td style="width: 33%;">Service</td> <td style="width: 33%; text-align: center;"><input type="checkbox"/></td> <td style="width: 33%;">Repair</td> <td style="width: 33%; text-align: center;"><input checked="" type="checkbox"/></td> <td style="width: 33%;">optional</td> <td style="width: 33%; text-align: center;"><input type="checkbox"/></td> </tr> </table>	Service	<input type="checkbox"/>	Repair	<input checked="" type="checkbox"/>	optional	<input type="checkbox"/>
Service	<input type="checkbox"/>	Repair	<input checked="" type="checkbox"/>	optional	<input type="checkbox"/>			
79429002000 Holder and fitting for work stand								
 <p>79429002000</p>	<p>Description/example of use</p> <p>Tool for securing the removed engine on the engine assembly stand for use with 80329001000</p> <p>used with model</p> <p>FC 450 2016 FC 450 2017 FC 450 2018 FE 450 2017 FE 450 2018 FE 501 2017 FE 501 2018 FE 501 S 2017 FE 501 S 2018 FX 450 FS 450 2016 FS 450 2017 FS 450 2018</p>	<table border="1" style="width: 100%; border-collapse: collapse;"> <tr> <td style="width: 33%;">Service</td> <td style="width: 33%; text-align: center;"><input type="checkbox"/></td> <td style="width: 33%;">Repair</td> <td style="width: 33%; text-align: center;"><input checked="" type="checkbox"/></td> <td style="width: 33%;">optional</td> <td style="width: 33%; text-align: center;"><input type="checkbox"/></td> </tr> </table>	Service	<input type="checkbox"/>	Repair	<input checked="" type="checkbox"/>	optional	<input type="checkbox"/>
Service	<input type="checkbox"/>	Repair	<input checked="" type="checkbox"/>	optional	<input type="checkbox"/>			
90129002000 Holder and fitting for work stand								
 <p>90129002000</p>	<p>Description/example of use</p> <p>Tool for securing the removed engine on the engine assembly stand for use with 80329001000</p> <p>used with model</p> <p>Naked Small</p>	<table border="1" style="width: 100%; border-collapse: collapse;"> <tr> <td style="width: 33%;">Service</td> <td style="width: 33%; text-align: center;"><input type="checkbox"/></td> <td style="width: 33%;">Repair</td> <td style="width: 33%; text-align: center;"><input checked="" type="checkbox"/></td> <td style="width: 33%;">optional</td> <td style="width: 33%; text-align: center;"><input type="checkbox"/></td> </tr> </table>	Service	<input type="checkbox"/>	Repair	<input checked="" type="checkbox"/>	optional	<input type="checkbox"/>
Service	<input type="checkbox"/>	Repair	<input checked="" type="checkbox"/>	optional	<input type="checkbox"/>			

6.1 Wall tool organizer overview

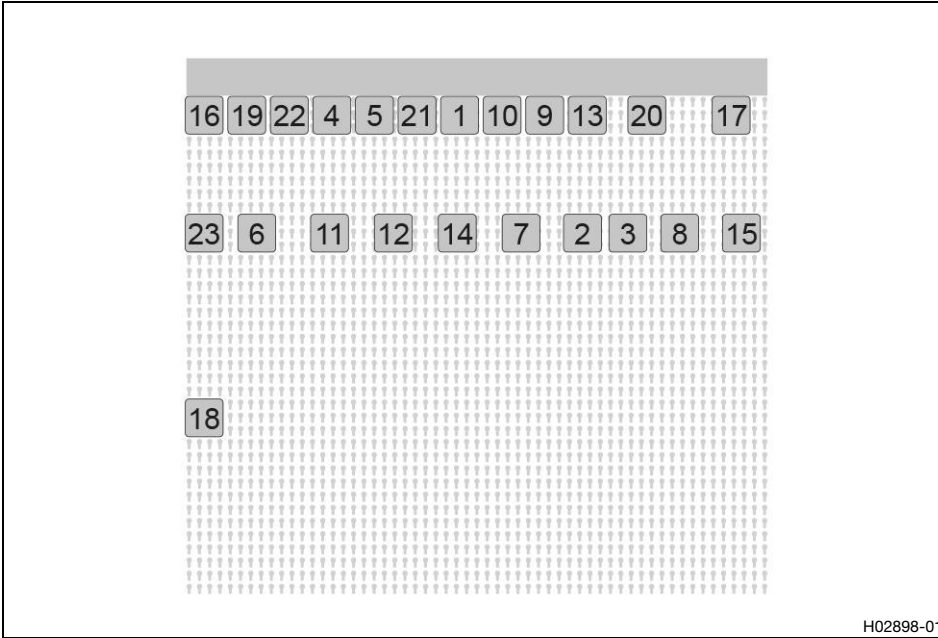

H02898-01

1	Locking screw (113080802) (📖 p. 42)
2	Holding wrench (45229012000) (📖 p. 43)
3	Holding wrench (45229050000) (📖 p. 43)
4	Gear segment (45229081000) (📖 p. 43)
5	Gear segment (46229081000) (📖 p. 43)
6	Holding wrench (47029003000) (📖 p. 44)
7	Holding wrench (47229003000) (📖 p. 44)
8	Holding wrench (49012003000) (📖 p. 44)
9	Holding wrench (50329004000) (📖 p. 44)
10	Support tool (50329038000) (📖 p. 44)
11	Holding wrench (50429003000) (📖 p. 45)
12	Holding wrench (51129003000) (📖 p. 45)
13	Holding wrench (54629012200) (📖 p. 45)
14	Holding wrench (55129001000) (📖 p. 46)
15	Holding wrench (55429012000) (📖 p. 46)
16	Gear segment (56012004000) (📖 p. 46)
17	Support tool (59029003100) (📖 p. 46)
18	Locking screw (61229015000) (📖 p. 47)
19	Gear segment (75029081000) (📖 p. 47)
20	Holding wrench (75029091000) (📖 p. 47)
21	Locking screw (77329010000) (📖 p. 47)
22	Gear segment (80029004000) (📖 p. 47)
23	Hook wrench (90129051000) (📖 p. 48)

113080802 Locking screw

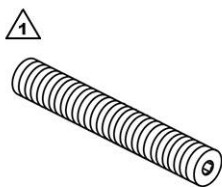

113080802



Description/example of use



Tool for securing components (crankshaft in TDC position)

used with model

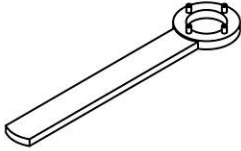
FC 450

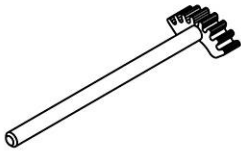
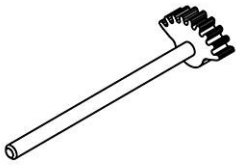
FE 450

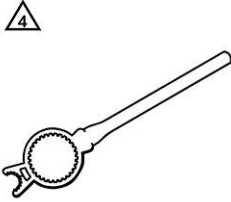
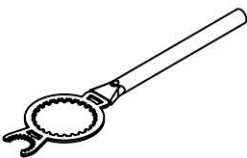
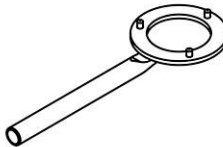
113080802 Locking screw			
	Enduro E3 4 stroke FX 450 Supermoto Competition		
	Service	<input checked="" type="checkbox"/>	Repair optional <input type="checkbox"/>
45229012000 Holding wrench			
 45229012000	Description/example of use Tool for holding components (rotor)		
	used with model TC 50		
Service	<input type="checkbox"/>	Repair	<input checked="" type="checkbox"/> optional <input type="checkbox"/>
45229050000 Holding wrench			
 45229050000	Description/example of use Tool for holding, loosening and tightening components (steering head)		
	used with model TC 50		
Service	<input checked="" type="checkbox"/>	Repair	<input type="checkbox"/> optional <input type="checkbox"/>
45229081000 Gear segment			
 45229081000	Description/example of use Tool for holding components (clutch)		
	used with model TC 50		
Service	<input type="checkbox"/>	Repair	<input checked="" type="checkbox"/> optional <input type="checkbox"/>
46229081000 Gear segment			
 46229081000	Description/example of use Tool for holding components (clutch)		
	used with model TC 65		
Service	<input type="checkbox"/>	Repair	<input checked="" type="checkbox"/> optional <input type="checkbox"/>

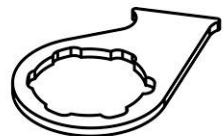
47029003000 Holding wrench			
 <p>47029003000</p>	Description/example of use Tool for holding components (clutch, primary gear)		
	used with model TC 85 2014 TC 85 2015 TC 85 2016 TC 85 2017		
Service	<input checked="" type="checkbox"/>	Repair	<input type="checkbox"/>
optional			<input type="checkbox"/>
47229003000 Holding wrench			
 <p>47229003000</p>	Description/example of use Tool for holding components (clutch, primary gear)		
	used with model TC 85 2018		
Service	<input checked="" type="checkbox"/>	Repair	<input type="checkbox"/>
optional			<input type="checkbox"/>
49012003000 Holding wrench			
 <p>49012003000</p>	Description/example of use Tool for holding components (clutch)		
	used with model TC 65		
Service	<input checked="" type="checkbox"/>	Repair	<input type="checkbox"/>
optional			<input type="checkbox"/>
50329004000 Holding wrench			
 <p>50329004000</p>	Description/example of use Tool for holding components (primary gear)		
	used with model TC 125 2014 TC 125 2015 TE 125		
Service	<input type="checkbox"/>	Repair	<input checked="" type="checkbox"/>
optional			<input type="checkbox"/>
50329038000 Support tool			
 <p>50329038000</p>	Description/example of use Tool for holding components (locating drum)		
	used with model TC 125 2014 TC 125 2015 TE 125		
Service	<input checked="" type="checkbox"/>	Repair	<input type="checkbox"/>
optional			<input type="checkbox"/>

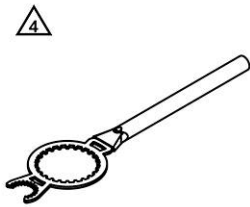
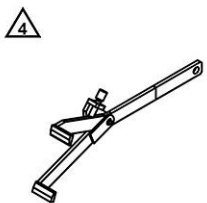
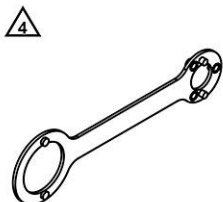

50429003000 Holding wrench			
 <p>50429003000</p>	<p>Description/example of use</p> <p>Tool for holding components (clutch, primary gear)</p>		
	<p>used with model</p> <p>TC 125 2016</p> <p>TC 125 2017</p> <p>TC 125 2018</p> <p>TE 150</p> <p>TX 125</p>		
Service	<input checked="" type="checkbox"/>	Repair	<input type="checkbox"/>
		optional	<input type="checkbox"/>
51129003000 Holding wrench			
 <p>51129003000</p>	<p>Description/example of use</p> <p>Tool for holding components (clutch)</p>		
	<p>used with model</p> <p>MX1 2 stroke</p> <p>FC 350 2016</p> <p>FC 350 2017</p> <p>FC 350 2018</p> <p>FC 450</p> <p>TC 125 2014</p> <p>TC 125 2015</p> <p>MX2 4 stroke</p> <p>TE 125</p> <p>Enduro E1 4 stroke</p> <p>Enduro E2</p> <p>Enduro E3</p> <p>Cross Country</p> <p>FS 450 2018</p> <p>Naked Small</p>		
Service	<input checked="" type="checkbox"/>	Repair	<input type="checkbox"/>
		optional	<input type="checkbox"/>
54629012200 Holding wrench			
 <p>54629012200</p>	<p>Description/example of use</p> <p>Tool for holding components (clutch, rotor)</p>		
	<p>used with model</p> <p>Mini</p> <p>MX1 2 stroke</p> <p>MX2 2 stroke</p> <p>Enduro E1 2 stroke</p> <p>TE 250 2017</p> <p>TE 250 2018</p> <p>TE 300 2017</p> <p>TE 300 2018</p> <p>Cross Country E3</p>		
Service	<input type="checkbox"/>	Repair	<input checked="" type="checkbox"/>
		optional	<input type="checkbox"/>

55129001000 Holding wrench			
 <p>55129001000</p>	Description/example of use Tool for holding components (rotor)		
	used with model TE 150 TX 125 TE 250 2014 TE 250 2015 TE 250 2016 TE 300 2014 TE 300 2015 TE 300 2016		
Service	<input type="checkbox"/>	Repair	<input checked="" type="checkbox"/>
optional	<input type="checkbox"/>		

55429012000 Holding wrench			
 <p>55429012000</p>	Description/example of use Tool for holding components (rotor)		
	used with model TC 250 2017 TC 250 2018 TE 250 2017 TE 250 2018 TE 300 2017 TE 300 2018 Cross Country E3		
Service	<input type="checkbox"/>	Repair	<input checked="" type="checkbox"/>
optional	<input type="checkbox"/>		

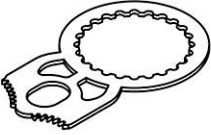
56012004000 Gear segment			
 <p>56012004000</p>	Description/example of use Tool for holding components (clutch)		
	used with model MX1 2 stroke Enduro E2 2 stroke Enduro E3 2 stroke Cross Country E3		
Service	<input type="checkbox"/>	Repair	<input checked="" type="checkbox"/>
optional	<input type="checkbox"/>		

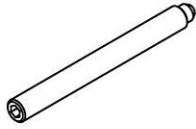
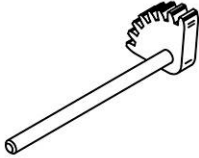
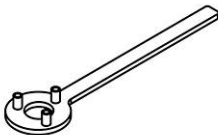
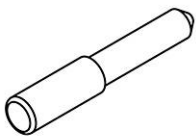
59029003100 Support tool			
 <p>59029003100</p>	Description/example of use Tool for holding components (clutch)		
	used with model FC 350 2014 FC 350 2015		
Service	<input checked="" type="checkbox"/>	Repair	<input type="checkbox"/>
optional	<input type="checkbox"/>		

61229015000 Locking screw			
 <p>61229015000</p>	<p>Description/example of use Tool for securing components (crankshaft in TDC position)</p> <p>used with model Naked Bike</p>	Service	<input checked="" type="checkbox"/>
		Repair	<input type="checkbox"/>
optional <input type="checkbox"/>			
75029081000 Gear segment			
 <p>75029081000</p>	<p>Description/example of use Tool for holding components (clutch)</p> <p>used with model Supermoto / Dual Sport Street Enduro Naked Mid</p>	Service	<input type="checkbox"/>
		Repair	<input checked="" type="checkbox"/>
optional <input type="checkbox"/>			
75029091000 Holding wrench			
 <p>75029091000</p>	<p>Description/example of use Tool for holding components (rotor)</p> <p>used with model Supermoto / Dual Sport Street Enduro Naked Mid</p>	Service	<input type="checkbox"/>
		Repair	<input checked="" type="checkbox"/>
optional <input type="checkbox"/>			
77329010000 Locking screw			
 <p>77329010000</p>	<p>Description/example of use Tool for securing components (crankshaft in TDC position)</p> <p>used with model Supermoto / Dual Sport Street Enduro</p>	Service	<input checked="" type="checkbox"/>
		Repair	<input type="checkbox"/>
optional <input type="checkbox"/>			
80029004000 Gear segment			
 <p>80029004000</p>	<p>Description/example of use Tool for holding components (clutch)</p> <p>used with model FC 450 FE 450 Enduro E3 4 stroke FX 450 Supermoto Competition</p>	Service	<input type="checkbox"/>
		Repair	<input checked="" type="checkbox"/>
optional <input type="checkbox"/>			

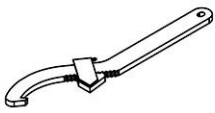
90129051000 Hook wrench					
<div style="text-align: center;">   <p>90129051000</p> </div>	<p>Description/example of use</p> <p>Tool for securing components (steering head bearing)</p> <p>used with model</p> <p>TC 85 2018</p> <p>TC 250 2017</p> <p>TC 250 2018</p> <p>FC 350 2017</p> <p>FC 350 2018</p> <p>FC 450 2017</p> <p>FC 450 2018</p> <p>TC 125 2017</p> <p>TC 125 2018</p> <p>FC 250 2017</p> <p>FC 250 2018</p> <p>TE 150</p> <p>TX 125</p> <p>FE 250 2017</p> <p>FE 250 2018</p> <p>TE 250 2017</p> <p>TE 250 2018</p> <p>FE 350 2017</p> <p>FE 350 2018</p> <p>FE 350 S 2017</p> <p>FE 350 S 2018</p> <p>FE 450 2017</p> <p>FE 450 2018</p> <p>TE 300 2017</p> <p>TE 300 2018</p> <p>FE 501 2017</p> <p>FE 501 2018</p> <p>FE 501 S 2017</p> <p>FE 501 S 2018</p> <p>Cross Country</p> <p>FS 450 2017</p> <p>FS 450 2018</p> <p>Naked Small</p>	<table border="1" style="width: 100%; border-collapse: collapse;"> <tr> <td style="width: 33%; padding: 2px;">Service <input checked="" type="checkbox"/></td> <td style="width: 33%; padding: 2px;">Repair <input type="checkbox"/></td> <td style="width: 33%; padding: 2px;">optional <input type="checkbox"/></td> </tr> </table>	Service <input checked="" type="checkbox"/>	Repair <input type="checkbox"/>	optional <input type="checkbox"/>
Service <input checked="" type="checkbox"/>	Repair <input type="checkbox"/>	optional <input type="checkbox"/>			

7.1 Overview

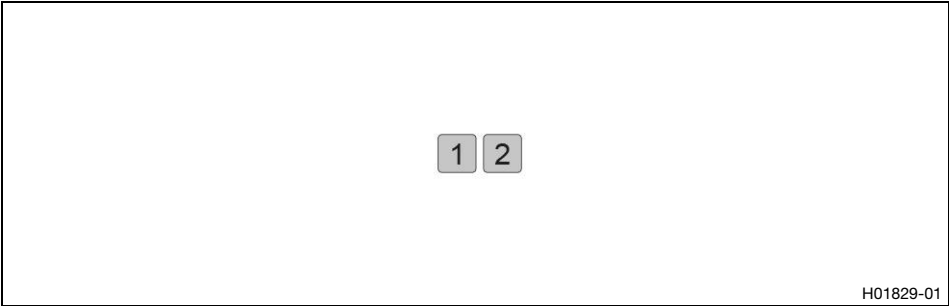

H01829-01

- 1 Torque wrench kit (58429094000) (📖 p. 49)
- 2 Fork airpump (79412966000) (📖 p. 49)

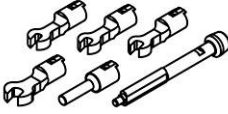
58429094000 Torque wrench kit		
 <p>58429094000</p>	<p>Description/example of use</p> <p>Torque wrench with various bits in the kit for tightening fittings to tightening torque (spokes)</p> <p>Technical data</p> <p>Torque: 3 ... 15 Nm (2.2 ... 11.1 lbf ft)</p> <p>Open ended bit: 3.9 mm (0.154 in)</p> <p>Open ended bit: 4.9 mm (0.193 in)</p> <p>Open ended bit: 5.5 mm (0.217 in)</p> <p>Open ended bit: 6.8 mm (0.268 in)</p> <p>Bit diameter: 5.9 mm (0.232 in)</p> <p>used with model</p> <p>Offroad</p> <p>Supermoto</p> <p>Street Enduro</p>	
	<p>Service <input checked="" type="checkbox"/></p>	<p>Repair <input type="checkbox"/></p>

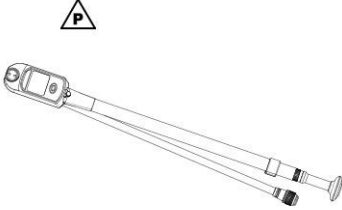
79412966000 Fork airpump		
 <p>79412966000</p>	<p>Description/example of use</p> <p>Pump for adjusting fork air pressure on the air suspension fork</p> <p>Technical data</p> <p>Maximum pressure: 20 bar (290 psi)</p> <p>Display: Digital pressure gauge</p> <p>Valve connection: Schrader valve</p> <p>Units: bar, psi and kg/cm²</p> <p>Material: Aluminum tube</p> <p>used with model</p> <p>TC 50</p> <p>TC 65</p> <p>TC 85 2018</p> <p>TC 250 2017</p> <p>TC 250 2018</p> <p>FC 450 2017</p> <p>FC 450 2018</p> <p>TC 125 2017</p> <p>TC 125 2018</p> <p>FC 250 2017</p> <p>FC 250 2018</p> <p>FX 450</p>	
	<p>Service <input type="checkbox"/></p>	

79412966000 Fork airpump			
		Cross Country E3 FS 450 2017 FS 450 2018	
Service	<input checked="" type="checkbox"/>	Repair	<input type="checkbox"/>
		optional	<input type="checkbox"/>

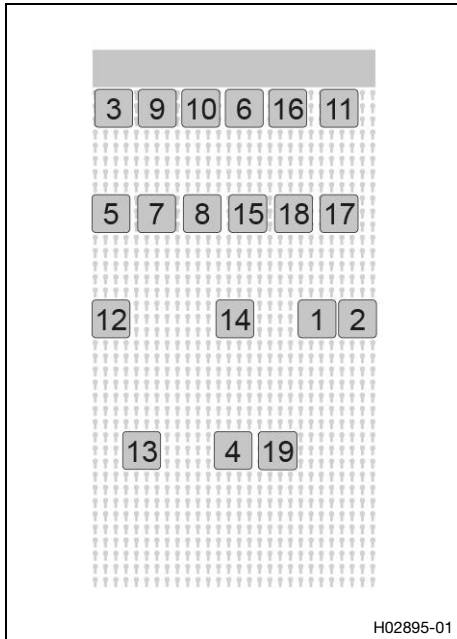

7.2 Wall tool organizer overview



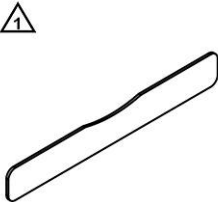

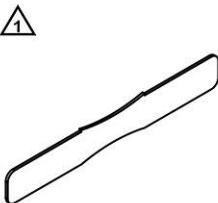

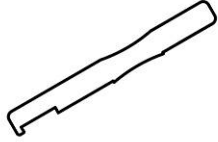
- 1 Setting gauge (45129006000) (📖 p. 50)
- 2 Setting gauge (46129006100) (📖 p. 50)
- 3 Setting gauge (47029006000) (📖 p. 51)
- 4 Measurement cap (47229031000) (📖 p. 51)
- 5 Dial gauge (50112013000) (📖 p. 51)
- 6 Dial gauge support (50112030000) (📖 p. 51)
- 7 Measurement cap (50329031000) (📖 p. 51)
- 8 Measurement cap (50429031000) (📖 p. 52)
- 9 Setting gauge (54829001100) (📖 p. 52)
- 10 Feeler gauge (59029041100) (📖 p. 52)
- 11 Angle disc (60029010000) (📖 p. 52)
- 12 **Plastigauge** clearance gauge (60029012000) (📖 p. 53)
- 13 Testing hose (61029093000) (📖 p. 53)
- 14 Pressure testing tool (61029094000) (📖 p. 53)
- 15 Oil pressure adapter (75029094000) (📖 p. 54)
- 16 Oil pressure adapter (77329006000) (📖 p. 54)
- 17 Banjo bolt (79329006000) (📖 p. 54)
- 18 Oil pressure adapter (79429094000) (📖 p. 55)
- 19 Oil pressure adapter (90129094000) (📖 p. 55)

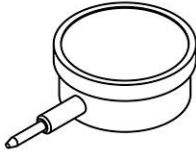
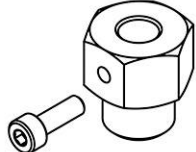
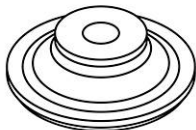
45129006000 Setting gauge			
 <p>45129006000</p>	Description/example of use Tool for checking the X dimension (piston protrusion)		
	used with model TC 50		
Service	<input checked="" type="checkbox"/>	Repair	<input type="checkbox"/>
		optional	<input type="checkbox"/>

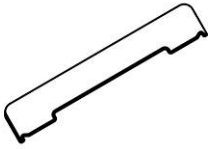
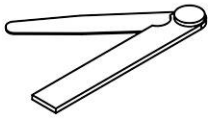
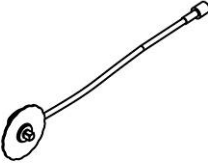
46129006100 Setting gauge			
 <p>46129006100</p>	Description/example of use Tool for checking the X dimension (piston protrusion) and the ignition setting		
	used with model TC 65		
Service	<input checked="" type="checkbox"/>	Repair	<input type="checkbox"/>
		optional	<input type="checkbox"/>

47029006000 Setting gauge			
 <p>47029006000</p>	Description/example of use Tool for checking the X dimension (piston protrusion) and the ignition setting		
	used with model TC 85 2014 TC 85 2015 TC 85 2016 TC 85 2017		
Service	<input checked="" type="checkbox"/>	Repair	<input type="checkbox"/>
optional			<input type="checkbox"/>
47229031000 Measurement cap			
 <p>47229031000</p>	Description/example of use Tool for dial gauge, for checking the X dimension (piston protrusion)		
	for use with 50112030000 used with model TC 85 2018		
Service	<input checked="" type="checkbox"/>	Repair	<input type="checkbox"/>
optional			<input type="checkbox"/>
50112013000 Dial gauge			
 <p>50112013000</p>	Description/example of use Measuring device for measuring lengths or length differences, for checking the X dimension (piston protrusion)		
	used with model TC 85 2018 MX2 2 stroke Enduro E1 2 stroke		
		matching tools / articles are 50112030000	
Service	<input checked="" type="checkbox"/>	Repair	<input type="checkbox"/>
optional			<input type="checkbox"/>
50112030000 Dial gauge support			
 <p>50112030000</p>	Description/example of use Tool for dial gauge, for checking the X dimension (piston protrusion)		
	for use with 50112013000 used with model MX2 2 stroke Enduro E1 2 stroke		
		matching tools / articles are 47229031000 50329031000 50429031000	
Service	<input checked="" type="checkbox"/>	Repair	<input type="checkbox"/>
optional			<input type="checkbox"/>
50329031000 Measurement cap			
 <p>50329031000</p>	Description/example of use Tool for dial gauge, for checking the X dimension (piston protrusion)		
	for use with 50112030000 used with model TC 125 2014 TC 125 2015 TE 125		
Service	<input checked="" type="checkbox"/>	Repair	<input type="checkbox"/>
optional			<input type="checkbox"/>

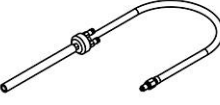
50429031000 Measurement cap			
 <p>50429031000</p>	<p>Description/example of use</p> <p>Tool for dial gauge, for checking the X dimension (piston protrusion)</p> <p>for use with 50112030000</p> <p>used with model</p> <p>TC 125 2016 TC 125 2017 TC 125 2018 TE 150 TX 125</p>		
	Service	<input checked="" type="checkbox"/>	Repair optional
54829001100 Setting gauge			
 <p>54829001100</p>	<p>Description/example of use</p> <p>Tool for checking the X dimension (piston protrusion)</p> <p>used with model</p> <p>MX1 2 stroke Enduro E2 2 stroke Enduro E3 2 stroke Cross Country E3</p>		
	Service	<input checked="" type="checkbox"/>	Repair optional
59029041100 Feeler gauge			
 <p>59029041100</p>	<p>Description/example of use</p> <p>Tool for checking and measuring installed gaps</p> <p>Technical data</p> <p>5 piece: 0.10 ... 0.25 mm (0.0039 ... 0.0098 in)</p> <p>used with model</p> <p>Husqvarna</p>		
	Service	<input checked="" type="checkbox"/>	Repair optional
60029010000 Angle disc			
 <p>60029010000</p>	<p>Description/example of use</p> <p>Tool for tightening bolts with rotation angle (cylinder head nuts, conrod bearing bolts)</p> <p>Technical data</p> <p>Driver system / tip: 1/2 in</p> <p>used with model</p> <p>FC 350 2014 FC 350 2015 FC 250 2014 FC 250 2015 FE 250 2014 FE 250 2015 FE 250 2016</p>		
	Service	<input type="checkbox"/>	Repair optional

60029012000 Plastigauge clearance gauge		
 60029012000	Description/example of use Tool for measuring bearing play Technical data 0.025 ... 0.175 mm (0.00098 ... 0.00689 in) used with model FC 350 MX2 4 stroke Enduro E1 4 stroke FE 350 FE 350 S FX 350 Naked Small	Service <input type="checkbox"/> Repair <input checked="" type="checkbox"/> optional <input type="checkbox"/>
61029093000 Testing hose		
 61029093000	Description/example of use Hose for pressure testing tool, for checking the fuel pressure for use with 61029094000 used with model MX1 4 stroke MX2 4 stroke Enduro E1 4 stroke TE 250i EU 2018 TE 250i US 2018 Enduro E2 4 stroke TE 300i EU 2018 Enduro E3 4 stroke Cross Country E2 Street	Service <input checked="" type="checkbox"/> Repair <input type="checkbox"/> optional <input type="checkbox"/>
61029094000 Pressure testing tool		
 61029094000	Description/example of use Tool for checking fuel and oil pressure used with model MX1 4 stroke MX2 4 stroke Enduro E1 4 stroke TE 250i EU 2018 TE 250i US 2018 Enduro E2 4 stroke TE 300i EU 2018 Enduro E3 4 stroke Cross Country E2 Street	matching tools / articles are 61029093000 75029094000 77329006000 79329006000 79429094000 90129094000
Service <input checked="" type="checkbox"/> Repair <input type="checkbox"/> optional <input type="checkbox"/>		

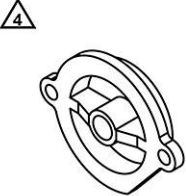
75029094000 Oil pressure adapter		
 <p>75029094000</p>	Description/example of use Adapter for pressure testing tool, for checking oil pressure for use with 61029094000	
	used with model FC 450 2014 FC 450 2015 FE 450 2014 FE 450 2015 FE 450 2016 FE 501 2014 FE 501 2015 FE 501 2016 FE 501 S 2015 FE 501 S 2016 FS 450 2015	
Service	<input type="checkbox"/>	Repair <input checked="" type="checkbox"/> optional <input type="checkbox"/>

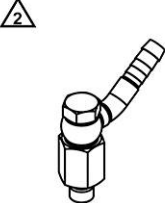
77329006000 Oil pressure adapter		
 <p>77329006000</p>	Description/example of use Adapter for pressure testing tool, for checking oil pressure for use with 61029094000	
	used with model FC 350 MX2 4 stroke Enduro E1 4 stroke FE 350 FE 350 S FX 350 Supermoto / Dual Sport Street Enduro Naked Mid	
Service	<input type="checkbox"/>	Repair <input checked="" type="checkbox"/> optional <input type="checkbox"/>

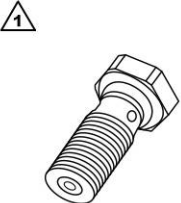
79329006000 Banjo bolt		
 <p>79329006000</p>	Description/example of use Banjo bolt for pressure testing tool, for checking oil pressure for use with 61029094000	
	used with model FC 350 2017 FC 350 2018 FC 250 2017 FC 250 2018 FE 250 2017 FE 250 2018 FE 350 2017 FE 350 2018 FE 350 S 2017 FE 350 S 2018 FX 350	
Service	<input type="checkbox"/>	Repair <input checked="" type="checkbox"/> optional <input type="checkbox"/>

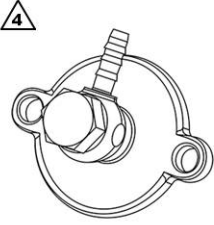
79429094000 Oil pressure adapter		
 <p>79429094000</p>	<p>Description/example of use</p> <p>Adapter for pressure testing tool, for checking oil pressure</p> <p style="text-align: right;">for use with 61029094000</p> <p>used with model</p> <p>FC 450 2016 FC 450 2017 FC 450 2018 FE 450 2017 FE 450 2018 FE 501 2017 FE 501 2018 FE 501 S 2017 FE 501 S 2018 FX 450 FS 450 2016 FS 450 2017 FS 450 2018</p>	
Service	<input type="checkbox"/>	Repair <input checked="" type="checkbox"/>
		optional <input type="checkbox"/>

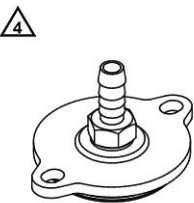
90129094000 Oil pressure adapter		
 <p>90129094000</p>	<p>Description/example of use</p> <p>Adapter for pressure testing tool, for checking oil pressure</p> <p style="text-align: right;">for use with 61029094000</p> <p>used with model</p> <p>Naked Small</p>	
Service	<input type="checkbox"/>	Repair <input checked="" type="checkbox"/>
		optional <input type="checkbox"/>

8.1 Wall tool organizer overview

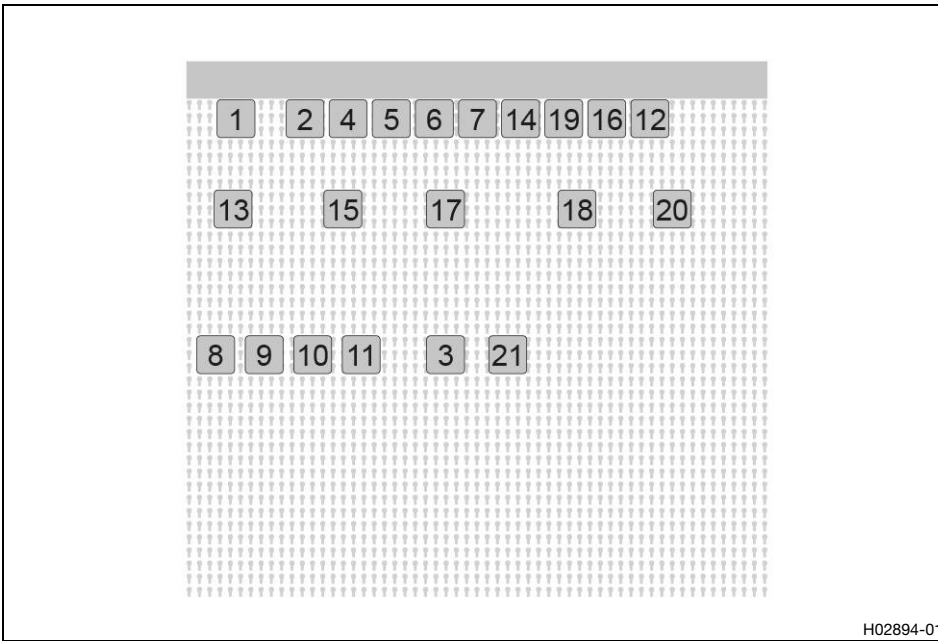

H02894-01

1	Bearing puller (15112017000) (📖 p. 56)
2	Internal bearing puller (15112018100) (📖 p. 57)
3	Extractor (45229048000) (📖 p. 57)
4	Puller (46129021000) (📖 p. 57)
5	Puller (54629009044) (📖 p. 58)
6	Puller (58012009000) (📖 p. 58)
7	Puller (58429009000) (📖 p. 58)
8	Puller (58429037031) (📖 p. 58)
9	Puller (58429037037) (📖 p. 59)
10	Puller (58429037040) (📖 p. 59)
11	Puller (58429037043) (📖 p. 59)
12	Puller (59029033000) (📖 p. 60)
13	Puller (60029033000) (📖 p. 60)
14	Puller (75029021000) (📖 p. 60)
15	Puller (75029048100) (📖 p. 61)
16	Puller (77229001044) (📖 p. 61)
17	Puller (77229048000) (📖 p. 61)
18	Extractor (79229032044) (📖 p. 61)
19	Puller (79229048000) (📖 p. 62)
20	Puller (90129048100) (📖 p. 62)
21	Puller (90229009000) (📖 p. 63)

15112017000 Bearing puller

2x 

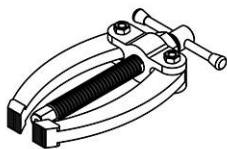

15112017000

Description/example of use

Tool for removing bearings from a housing

used with model

FC 450

FE 450

Enduro E3 4 stroke

FX 450

matching tools / articles are

15112018100

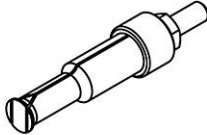
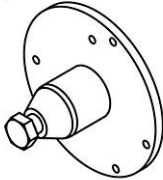
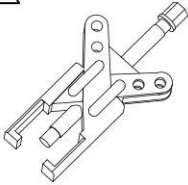
15112017000 Bearing puller		
	Supermoto Street Enduro Naked Mid	
	Service <input type="checkbox"/>	Repair <input checked="" type="checkbox"/>
		optional <input type="checkbox"/>
15112018100 Internal bearing puller		
 <p>15112018100</p>	Description/example of use Tool for removing bearings from a housing	
	Technical data 18 ... 23 mm (0.71 ... 0.91 in)	for use with 15112017000
	used with model FC 450 FE 450 Enduro E3 4 stroke FX 450 Supermoto Street Enduro Naked Mid	
	Service <input type="checkbox"/>	Repair <input checked="" type="checkbox"/>
		optional <input type="checkbox"/>
45229048000 Extractor		
 <p>45229048000</p>	Description/example of use Tool for disengaging components (sections of the engine case)	
	used with model TC 50 TC 65	
	Service <input type="checkbox"/>	Repair <input checked="" type="checkbox"/>
		optional <input type="checkbox"/>
46129021000 Puller		
 <p>46129021000</p>	Description/example of use Tool for pulling off components (primary gear wheel, sleeve, main shaft, rotor)	
	used with model TC 50 FC 350 MX2 4 stroke Enduro E1 4 stroke FE 350 2017 FE 350 2018 FE 350 S 2017 FE 350 S 2018 FX 350	
	Service <input type="checkbox"/>	Repair <input checked="" type="checkbox"/>
		optional <input type="checkbox"/>

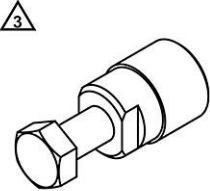
54629009044 Puller		
 <p>54629009044</p>	Description/example of use Tool for pulling off components (rotor)	
	used with model TC 65 TC 85 MX1 2 stroke MX2 2 stroke Enduro E1 2 stroke Cross Country E3	
Service	<input type="checkbox"/>	Repair <input checked="" type="checkbox"/> optional <input type="checkbox"/>

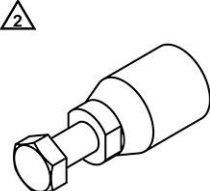
58012009000 Puller		
 <p>58012009000</p>	Description/example of use Tool for pulling off components (rotor)	
	used with model TC 250 2017 TC 250 2018 FC 350 2014 FC 350 2015 FC 450 2014 FC 450 2015 FC 250 2014 FC 250 2015 TE 150 TX 125 Enduro E1 4 stroke Enduro E2 Enduro E3 Cross Country E3 FS 450 2015	
Service	<input type="checkbox"/>	Repair <input checked="" type="checkbox"/> optional <input type="checkbox"/>

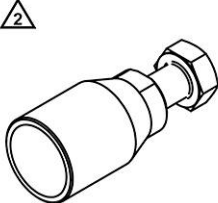

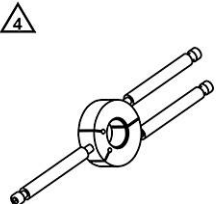

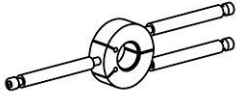

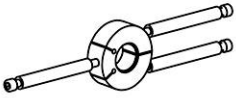
58429009000 Puller		
 <p>58429009000</p>	Description/example of use Tool for pulling off components (rotor)	
	used with model Supermoto / Dual Sport Street Enduro Naked Mid	
Service	<input type="checkbox"/>	Repair <input checked="" type="checkbox"/> optional <input type="checkbox"/>

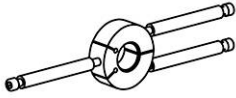
58429037031 Puller		
 <p>58429037031</p>	Description/example of use Tool for pulling off components (inner bearing race of crankshaft)	
	Technical data Inside diameter: 31.5 mm (1.24 in) used with model TC 85	
Service	<input type="checkbox"/>	Repair <input checked="" type="checkbox"/> optional <input type="checkbox"/>

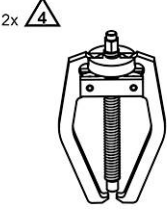
58429037037 Puller		
 <p>58429037037</p>	Description/example of use Tool for pulling off components (inner bearing race of crankshaft)	
	Technical data Inside diameter: 37.5 mm (1.476 in) used with model FC 350 MX2 Enduro E1 FE 350 FE 350 S FX 350	
Service	<input type="checkbox"/>	Repair <input checked="" type="checkbox"/> optional <input type="checkbox"/>

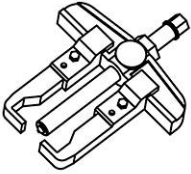
58429037040 Puller		
 <p>58429037040</p>	Description/example of use Tool for pulling off components (inner bearing race of crankshaft)	
	Technical data Inside diameter: 40.4 mm (1.591 in) used with model TC 250 2014 TC 250 2015 TC 250 2016 TE 250 2014 TE 250 2015 TE 250 2016 TE 300 2014 TE 300 2015 TE 300 2016	
Service	<input type="checkbox"/>	Repair <input checked="" type="checkbox"/> optional <input type="checkbox"/>

58429037043 Puller		
 <p>58429037043</p>	Description/example of use Tool for pulling off components (inner bearing race of crankshaft)	
	Technical data Inside diameter: 43.9 mm (1.728 in) used with model TC 250 2017 TC 250 2018 FC 450 2017 FC 450 2018 TE 250 2017 TE 250 2018 FE 450 2017 FE 450 2018 TE 300 2017 TE 300 2018 FE 501 2017 FE 501 2018 FE 501 S 2017 FE 501 S 2018 FX 450 Cross Country E3 Supermoto / Dual Sport	

58429037043 Puller			
	FS 450 2016 FS 450 2017 FS 450 2018 Street Enduro Naked Mid		
	Service <input type="checkbox"/>	Repair <input checked="" type="checkbox"/>	optional <input type="checkbox"/>
59029033000 Puller			
 <p>2x </p> <p>59029033000</p>	<p>Description/example of use</p> <p>Tool for pulling off components (timing chain sprocket)</p> <p>used with model</p> <p>701 Supermoto 2016 701 Enduro 2016</p>		
	Service <input type="checkbox"/>	Repair <input checked="" type="checkbox"/>	optional <input type="checkbox"/>
60029033000 Puller			
 <p>2x </p> <p>60029033000</p>	<p>Description/example of use</p> <p>Tool for pulling off components (timing chain sprocket)</p> <p>used with model</p> <p>FC 450 FE 450 2014 FE 450 2015 FE 450 2016 FE 501 2014 FE 501 2015 FE 501 2016 FE 501 S 2015 FE 501 S 2016 FX 450 FS 450 2015</p>		
	Service <input type="checkbox"/>	Repair <input checked="" type="checkbox"/>	optional <input type="checkbox"/>
75029021000 Puller			
 <p></p> <p>75029021000</p>	<p>Description/example of use</p> <p>Tool for pulling off components (primary gear wheel)</p> <p>used with model</p> <p>FC 450 FE 450 Enduro E3 4 stroke FX 450 Supermoto Street Enduro Naked Mid</p>		
	Service <input type="checkbox"/>	Repair <input checked="" type="checkbox"/>	optional <input type="checkbox"/>

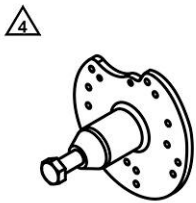
75029048100 Puller		
 <p>75029048100</p>	Description/example of use Tool for disengaging components (sections of the engine case)	
	used with model Supermoto / Dual Sport Street Enduro Naked Mid	
Service	<input type="checkbox"/>	Repair <input checked="" type="checkbox"/> optional <input type="checkbox"/>

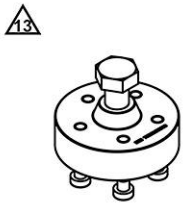
77229001044 Puller		
 <p>77229001044</p>	Description/example of use Tool for pulling off components (camshaft gear)	
	used with model FC 350 FC 250 2014 FE 350 2014 FE 350 2015 FE 350 2016 FE 350 S 2015 FE 350 S 2016 FX 350	
Service	<input type="checkbox"/>	Repair <input checked="" type="checkbox"/> optional <input type="checkbox"/>

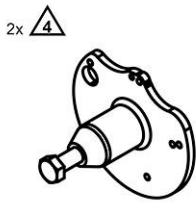
77229048000 Puller		
 <p>77229048000</p>	Description/example of use Tool for disengaging components (sections of the engine case)	
	used with model FC 350 2014 FC 350 2015 FC 250 2014 FC 250 2015 FE 250 2014 FE 250 2015 FE 250 2016 FE 350 2014 FE 350 2015 FE 350 2016 FE 350 S 2015 FE 350 S 2016	
Service	<input type="checkbox"/>	Repair <input checked="" type="checkbox"/> optional <input type="checkbox"/>

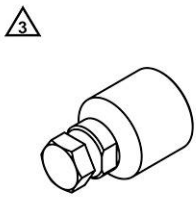
79229032044 Extractor		
 <p>79229032044</p>	Description/example of use Tool for pulling off components (rotor)	
	used with model FC 350 2016 FC 350 2017 FC 350 2018 FC 450 2016 FC 450 2017	

79229032044 Extractor		
	FC 450 2018 FC 250 2016 FC 250 2017 FC 250 2018 Cross Country E2 FS 450 2016 FS 450 2017 FS 450 2018	
	Service <input type="checkbox"/>	Repair <input checked="" type="checkbox"/>
	optional <input type="checkbox"/>	

79229048000 Puller		
 <p>79229048000</p>	Description/example of use Tool for disengaging components (sections of the engine case)	
	used with model FC 350 2016 FC 350 2017 FC 350 2018 FC 450 2016 FC 450 2017 FC 450 2018 FC 250 2016 FC 250 2017 FC 250 2018 FE 250 2017 FE 250 2018 FE 350 2017 FE 350 2018 FE 350 S 2017 FE 350 S 2018 FE 450 2017 FE 450 2018 FE 501 2017 FE 501 2018 FE 501 S 2017 FE 501 S 2018 Cross Country E2 FS 450 2016 FS 450 2017 FS 450 2018	
	Service <input type="checkbox"/>	Repair <input checked="" type="checkbox"/>
	optional <input type="checkbox"/>	

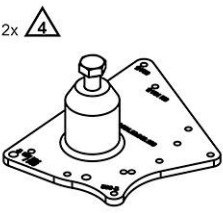
90129048100 Puller		
 <p>90129048100</p>	Description/example of use Tool for disengaging components (sections of the engine case, for pressing out the crankshaft)	
	used with model FC 450 2014 FC 450 2015 FE 450 2014 FE 450 2015 FE 450 2016	
	Service <input type="checkbox"/>	Repair <input checked="" type="checkbox"/>
	optional <input type="checkbox"/>	

90129048100 Puller			
	FE 501 2014 FE 501 2015 FE 501 2016 FE 501 S 2015 FE 501 S 2016 FS 450 2015 Naked Small		
	Service	<input type="checkbox"/>	Repair
		<input checked="" type="checkbox"/>	optional
			<input type="checkbox"/>

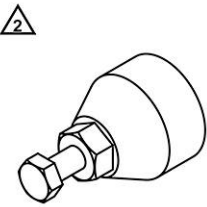
90229009000 Puller			
 <p>90229009000</p>	Description/example of use Tool for pulling off components (rotor)		
	used with model Naked Small		
Service	<input type="checkbox"/>	Repair	<input checked="" type="checkbox"/>
			optional
			<input type="checkbox"/>

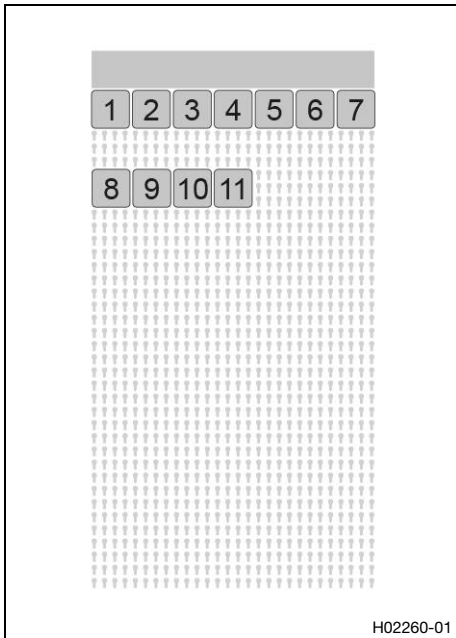

9.1 Wall tool organizer overview





H02260-01

- | | |
|----|---|
| 1 | Protection cap (45229090000) (📖 p. 64) |
| 2 | Protection cap (46229090000) (📖 p. 64) |
| 3 | Protection cap (58529005000) (📖 p. 64) |
| 4 | Protection cap (61229005100) (📖 p. 65) |
| 5 | Protecting sleeve (75029080000) (📖 p. 65) |
| 6 | Protecting sleeve (75029080050) (📖 p. 65) |
| 7 | Protection cap (75029090000) (📖 p. 65) |
| 8 | Protection cap (77229031000) (📖 p. 66) |
| 9 | Protection cap (78029005000) (📖 p. 66) |
| 10 | Protection cap (78029005100) (📖 p. 66) |
| 11 | Protection cap (90129005000) (📖 p. 66) |

45229090000 Protection cap





  45229090000	Description/example of use Tool for protecting components (when disengaging the sections of the engine case)		
	used with model TC 50		
Service	<input type="checkbox"/>	Repair	<input checked="" type="checkbox"/>
optional	<input type="checkbox"/>		

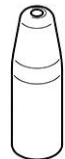

46229090000 Protection cap

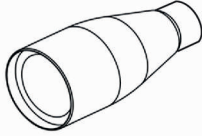
  46229090000	Description/example of use Tool for protecting components (when disengaging the sections of the engine case)		
	used with model TC 65 TC 85 2014 TC 85 2015 TC 85 2016 TC 85 2017		
Service	<input type="checkbox"/>	Repair	<input checked="" type="checkbox"/>
optional	<input type="checkbox"/>		

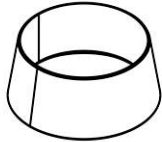
58529005000 Protection cap

  58529005000	Description/example of use Tool for protecting components (installation of crankshaft and balancer shaft)		
	used with model 701 Supermoto 2016 701 Supermoto 2017 701 Enduro 2016 701 Enduro 2017		
Service	<input type="checkbox"/>	Repair	<input checked="" type="checkbox"/>
optional	<input type="checkbox"/>		

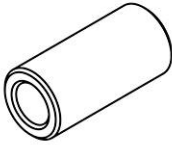
61229005100 Protection cap			
 <p>61229005100</p>	<p>Description/example of use</p> <p>Tool for protecting components (installation of clutch cover)</p> <p>used with model</p> <p>701 Supermoto 2018</p> <p>701 Enduro 2018</p> <p>Naked Mid</p>	Service	<input type="checkbox"/>
		Repair	<input checked="" type="checkbox"/>
		optional	<input type="checkbox"/>
75029080000 Protecting sleeve			
 <p>75029080000</p>	<p>Description/example of use</p> <p>Tool for protecting components (installation of crankshaft, balancer shaft and engine case)</p> <p>used with model</p> <p>Supermoto / Dual Sport</p> <p>Street Enduro</p> <p>Naked Mid</p>	Service	<input type="checkbox"/>
		Repair	<input checked="" type="checkbox"/>
		optional	<input type="checkbox"/>
75029080050 Protecting sleeve			
 <p>75029080050</p>	<p>Description/example of use</p> <p>Tool for protecting components (installation of crankshaft and balancer shaft)</p> <p>used with model</p> <p>701 Supermoto 2016</p> <p>701 Enduro 2016</p>	Service	<input type="checkbox"/>
		Repair	<input checked="" type="checkbox"/>
		optional	<input type="checkbox"/>
75029090000 Protection cap			
 <p>75029090000</p>	<p>Description/example of use</p> <p>Tool for protecting components (removal of primary gear wheel)</p> <p>used with model</p> <p>MX1 4 stroke</p> <p>MX2 4 stroke</p> <p>Enduro E1 4 stroke</p> <p>Enduro E2 4 stroke</p> <p>Enduro E3 4 stroke</p> <p>Cross Country E2</p> <p>Supermoto</p> <p>Street Enduro</p> <p>Naked Mid</p>	Service	<input type="checkbox"/>
		Repair	<input checked="" type="checkbox"/>
		optional	<input type="checkbox"/>

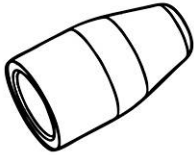
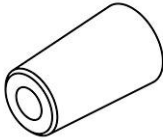
77229031000 Protection cap			
 <p>77229031000</p>	Description/example of use Tool for protecting components (removal of balancer shaft drive gear wheel)		
	used with model FC 350 MX2 4 stroke Enduro E1 4 stroke FE 350 FE 350 S FX 350		
Service	<input type="checkbox"/>	Repair	<input checked="" type="checkbox"/>
optional	<input type="checkbox"/>		
78029005000 Protection cap			
 <p>78029005000</p>	Description/example of use Tool for protecting components (installation of crankshaft)		
	used with model FE 450 2014 FE 450 2015 FE 450 2016 FE 501 2014 FE 501 2015 FE 501 2016 FE 501 S 2015 FE 501 S 2016		
Service	<input type="checkbox"/>	Repair	<input checked="" type="checkbox"/>
optional	<input type="checkbox"/>		
78029005100 Protection cap			
 <p>78029005100</p>	Description/example of use Tool for protecting components (installation of crankshaft)		
	used with model FC 450 2014 FC 450 2015 FS 450 2015		
Service	<input type="checkbox"/>	Repair	<input checked="" type="checkbox"/>
optional	<input type="checkbox"/>		
90129005000 Protection cap			
 <p>90129005000</p>	Description/example of use Tool for protecting components (water pump installation)		
	used with model FC 450 FE 450 Enduro E3 4 stroke FX 450 Supermoto Competition Naked Small		
Service	<input type="checkbox"/>	Repair	<input checked="" type="checkbox"/>
optional	<input type="checkbox"/>		

10.1 Overview



H02891-01

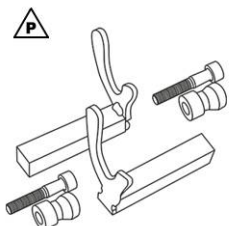

1	Universal V adapter with bushings (61029955144) (📖 p. 67)
2	Universal V adapter with bushings (61029955244) (📖 p. 67)
3	Front wheel work stand, small (61129965000) (📖 p. 68)
4	Work stand (62529055200) (📖 p. 68)
5	Rear wheel work stand (69329955000) (📖 p. 68)
6	Rear wheel work stand (6932995500033) (📖 p. 68)
7	Workshop adapter (69329955010) (📖 p. 68)
8	Mounting pin (69329965010) (📖 p. 69)
9	Mounting pin (69329965030) (📖 p. 69)
10	Front wheel work stand, large (6932996510033) (📖 p. 69)
11	Work stand attachments (75029036000) (📖 p. 69)
12	Floor jack attachment (75029055000) (📖 p. 69)
13	Lift stand (80329955100) (📖 p. 70)
14	Lift stand (81329955100) (📖 p. 70)

61029955144 Universal V adapter with bushings

 <p>61029955144</p>	Description/example of use Set consists of V adapter and bushings kit, for rear wheel work stand, for lifting the motorcycle at the link fork				
	for use with 69329955000 6932995500033 used with model Naked Mid				
Service	<input type="checkbox"/>	Repair	<input type="checkbox"/>	optional	<input checked="" type="checkbox"/>

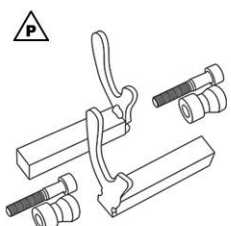
61029955244 Universal V adapter with bushings

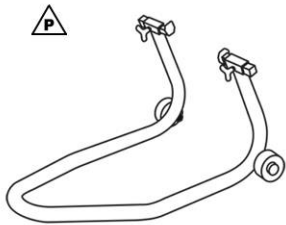
 <p>61029955244</p>	Description/example of use Set consists of V adapter and bushings kit, for rear wheel work stand, for lifting the motorcycle at the link fork				
	for use with 69329955000 6932995500033 used with model Naked Small				
Service	<input type="checkbox"/>	Repair	<input type="checkbox"/>	optional	<input checked="" type="checkbox"/>

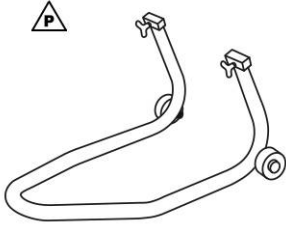
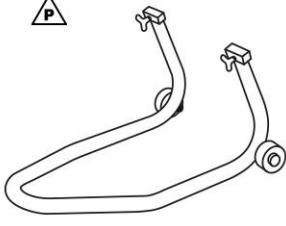
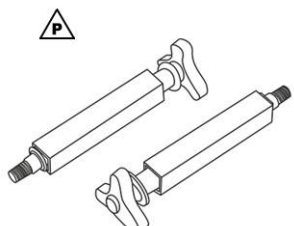
61129965000 Front wheel work stand, small			
 <p>61129965100</p>	Description/example of use Tool for lifting the motorcycle at the fork legs (incl. retaining adapter)		
	used with model Supermoto / Dual Sport		
Service	<input type="checkbox"/>	Repair	<input type="checkbox"/>
		optional	<input checked="" type="checkbox"/>
62529055200 Work stand			
 <p>62529055200</p>	Description/example of use Tool for lifting the motorcycle at the center		
	used with model Supermoto / Dual Sport Street Enduro Naked Bike		matching tools / articles are 75029036000
Service	<input checked="" type="checkbox"/>	Repair	<input type="checkbox"/>
		optional	<input type="checkbox"/>
69329955000 Rear wheel work stand			
 <p>69329955000</p>	Description/example of use Tool for lifting the motorcycle at the link fork		
	used with model Supermoto / Dual Sport Street Enduro		matching tools / articles are 61029955144 61029955244 69329955010
Service	<input type="checkbox"/>	Repair	<input type="checkbox"/>
		optional	<input checked="" type="checkbox"/>
6932995500033 Rear wheel work stand			
 <p>6932995500033</p>	Description/example of use Tool for lifting the motorcycle at the link fork		
	used with model Naked Bike		matching tools / articles are 61029955144 61029955244 69329955010
Service	<input type="checkbox"/>	Repair	<input type="checkbox"/>
		optional	<input checked="" type="checkbox"/>
69329955010 Workshop adapter			
 <p>69329955010</p>	Description/example of use Adapter for rear work stand, for lifting the motorcycle at the link fork		
	used with model Supermoto / Dual Sport Street Enduro		for use with 69329955000 6932995500033
Service	<input type="checkbox"/>	Repair	<input type="checkbox"/>
		optional	<input checked="" type="checkbox"/>

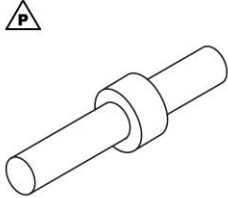
69329965010 Mounting pin			
 <p>69329965010</p>	Description/example of use Fitting for front work stand, for lifting the motorcycle at the triple clamp Technical data for use with Diameter: 14 mm (0.55 in) 6932996510033 used with model Naked Mid		
	Service <input type="checkbox"/>	Repair <input type="checkbox"/>	optional <input checked="" type="checkbox"/>

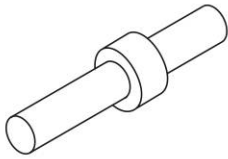
69329965030 Mounting pin			
 <p>69329965030</p>	Description/example of use Fitting for front work stand, for lifting the motorcycle at the triple clamp Technical data for use with Diameter: 19 mm (0.75 in) 6932996510033 used with model Naked Small		
	Service <input type="checkbox"/>	Repair <input type="checkbox"/>	optional <input checked="" type="checkbox"/>

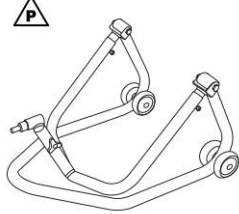
6932996510033 Front wheel work stand, large			
 <p>6932996510033</p>	Description/example of use Tool for lifting the motorcycle at the triple clamp used with model Naked Bike matching tools / articles are 69329965010 69329965030		
	Service <input type="checkbox"/>	Repair <input type="checkbox"/>	optional <input checked="" type="checkbox"/>

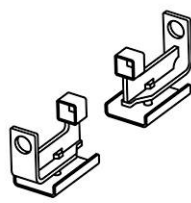
75029036000 Work stand attachments			
 <p>75029036000</p>	Description/example of use Attachments for work stand, for lifting the motorcycle at the center for use with 62529055200 used with model Supermoto / Dual Sport Street Enduro		
	Service <input checked="" type="checkbox"/>	Repair <input type="checkbox"/>	optional <input type="checkbox"/>

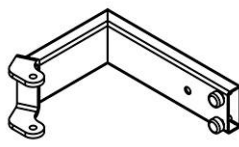
75029055000 Floor jack attachment			
 <p>75029055000</p>	Description/example of use Attachment for floor jack, for lifting engine used with model Supermoto / Dual Sport Street Enduro Naked Bike		
	Service <input type="checkbox"/>	Repair <input checked="" type="checkbox"/>	optional <input type="checkbox"/>

80329955100 Lift stand			
 <p>80329955100</p>	Description/example of use Tool for lifting the motorcycle Technical data Height: 260 ... 370 mm (10.24 ... 14.57 in) Load: ≤ 150 kg (≤ 331 lb.) used with model Mini Supermoto Competition		
	Service <input type="checkbox"/>	Repair <input type="checkbox"/>	optional <input checked="" type="checkbox"/>

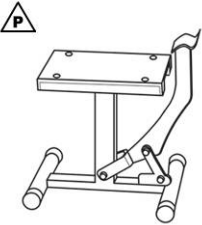
81329955100 Lift stand			
 <p>81329955100</p>	Description/example of use Tool for lifting the motorcycle Technical data Height: 315 ... 425 mm (12.4 ... 16.73 in) Load: ≤ 150 kg (≤ 331 lb.) used with model MX Enduro E1 Enduro E2 Enduro E3 Cross Country		
	Service <input type="checkbox"/>	Repair <input type="checkbox"/>	optional <input checked="" type="checkbox"/>

11.1 Wall tool organizer overview

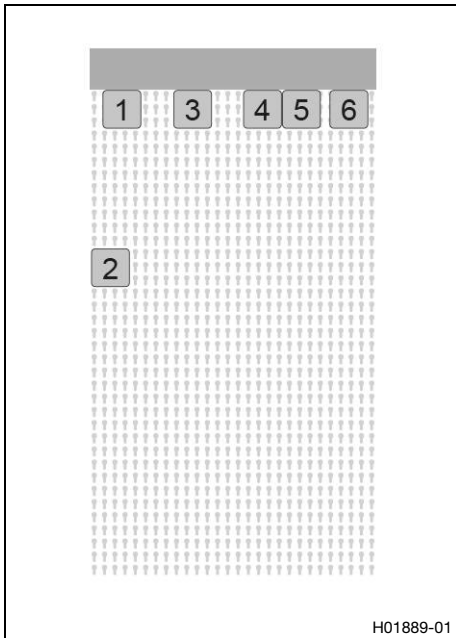

- | | |
|---|--|
| 1 | Lock ring plier (51012011000) (📖 p. 71) |
| 2 | Footrest spring plier (58429083000) (📖 p. 71) |
| 3 | Hose clamp plier (60029057000) (📖 p. 72) |
| 4 | Spring band clamps plier (60029057100) (📖 p. 72) |
| 5 | Valve stem seals plier (77229010000) (📖 p. 72) |
| 6 | Footrest spring plier (79029083000) (📖 p. 72) |

51012011000 Lock ring plier



51012011000

Description/example of use
Tool for removing the oil filter

used with model

MX1 4 stroke

MX2 4 stroke

Enduro E1 4 stroke

Enduro E2 4 stroke

Enduro E3 4 stroke

Cross Country E2

Street

Service

Repair

optional

58429083000 Footrest spring plier

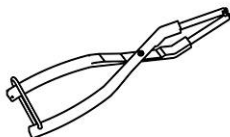

58429083000

Description/example of use

Tool for removing and mounting the rider footrests and removing the spacer from the starter motor

used with model

TE 250 2017

TE 250 2018

TE 300 2017

TE 300 2018

Cross Country E3

Service

Repair

optional

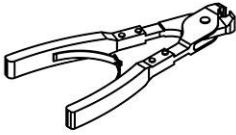
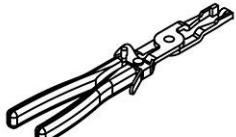
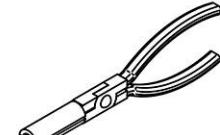
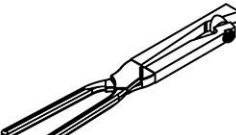
60029057000 Hose clamp plier			
 <p>60029057000</p>	Description/example of use Tool for mounting hose clamps		
	used with model MX1 4 stroke MX2 4 stroke Enduro E1 4 stroke TE 250i EU 2018 TE 250i US 2018 Enduro E2 4 stroke TE 300i EU 2018 Enduro E3 4 stroke Cross Country E2 Supermoto Street Enduro		
	Service	<input checked="" type="checkbox"/>	Repair
			<input type="checkbox"/>
	optional		<input type="checkbox"/>
60029057100 Spring band clamps plier			
 <p>60029057100</p>	Description/example of use Tool for moving spring band clamps		
	used with model Supermoto / Dual Sport Street Enduro Naked Bike		
	Service	<input checked="" type="checkbox"/>	Repair
			<input type="checkbox"/>
	optional		<input type="checkbox"/>
77229010000 Valve stem seals plier			
 <p>77229010000</p>	Description/example of use Tool for removing valve stem seals		
	used with model FC 350 MX2 4 stroke Enduro E1 4 stroke FE 350 FE 350 S FX 350 Naked Mid		
	Service	<input type="checkbox"/>	Repair
			<input checked="" type="checkbox"/>
	optional		<input type="checkbox"/>
79029083000 Footrest spring plier			
 <p>79029083000</p>	Description/example of use Tool for removing and mounting rider footrests		
	used with model TC 85 2018 TC 250 2017 TC 250 2018 FC 350 2016 FC 350 2017 FC 350 2018 FC 450 2016		

79029083000 Footrest spring plier			
	FC 450 2017		
	FC 450 2018		
	TC 125 2016		
	TC 125 2017		
	TC 125 2018		
	FC 250 2016		
	FC 250 2017		
	FC 250 2018		
	TE 150		
	TX 125		
	TE 250 2017		
	TE 250 2018		
	TE 300 2017		
	TE 300 2018		
	Cross Country		
	FS 450 2016		
	FS 450 2017		
	FS 450 2018		
Service	<input checked="" type="checkbox"/>	Repair <input type="checkbox"/>	optional <input type="checkbox"/>

12.1 Wall tool organizer overview

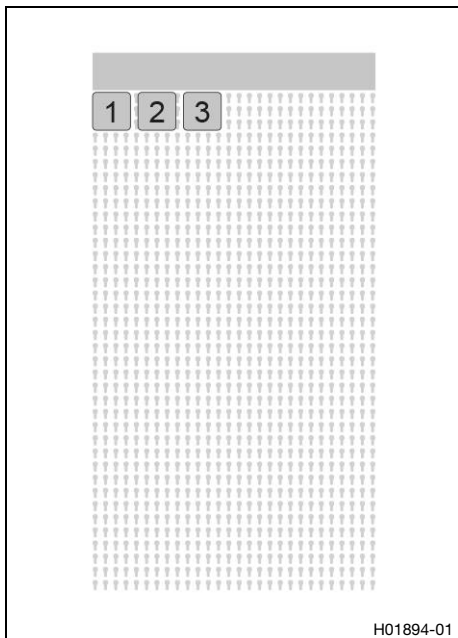

H01894-01

- | | |
|---|---|
| 1 | Spark plug wrench (60029073000) (📖 p. 74) |
| 2 | Spark plug wrench (75029172000) (📖 p. 74) |
| 3 | Spark plug wrench with link (77229172000) (📖 p. 74) |

60029073000 Spark plug wrench

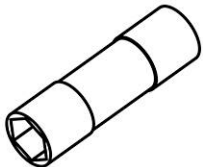
 <p>60029073000</p>	Description/example of use Tool for removing and installing spark plugs Technical data Drive: 1/2 in Hexagonal part: 16 mm (0.63 in) Length: 71 mm (2.8 in) used with model TC 65		
	Service <input checked="" type="checkbox"/>	Repair <input type="checkbox"/>	optional <input type="checkbox"/>

75029172000 Spark plug wrench

 <p>75029172000</p>	Description/example of use Tool for removing and installing spark plugs Technical data Drive: 1/2 in Hexagonal part: 14 mm (0.55 in) Length: 85 mm (3.35 in) used with model Supermoto / Dual Sport Street Enduro Naked Mid		
	Service <input checked="" type="checkbox"/>	Repair <input type="checkbox"/>	optional <input type="checkbox"/>

77229172000 Spark plug wrench with link

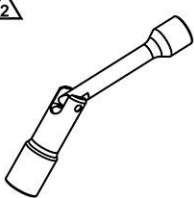
 <p>77229172000</p>	Description/example of use Tool for removing and installing spark plugs Technical data Drive: 3/8 in Hexagonal part: 14 mm (0.55 in) Length: 130 mm (5.12 in) used with model MX1 4 stroke MX2 4 stroke Enduro E1 4 stroke		
	Service <input checked="" type="checkbox"/>	Repair <input type="checkbox"/>	optional <input type="checkbox"/>

12 SPARK PLUG WRENCH

77229172000 Spark plug wrench with link			
	Enduro E2 4 stroke		
	Enduro E3 4 stroke		
	Cross Country E2		
	Supermoto Competition		
	Service <input checked="" type="checkbox"/>	Repair <input type="checkbox"/>	optional <input type="checkbox"/>

13.1 Wall tool organizer overview

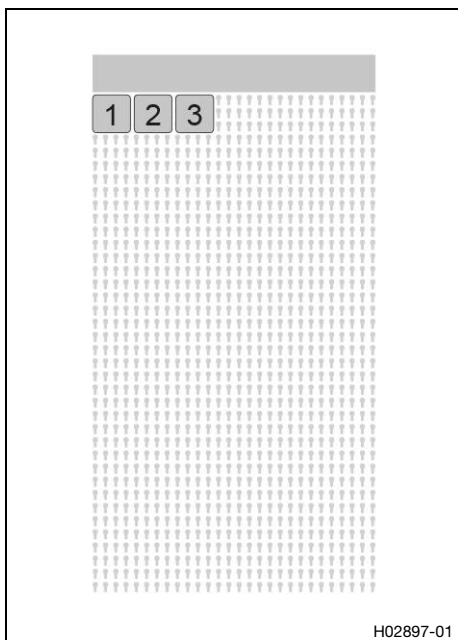

1	Groove nut wrench (75029034000) (📖 p. 76)
2	Groove nut wrench (90129022000) (📖 p. 76)
3	Groove nut wrench (90129050100) (📖 p. 76)

H02897-01

75029034000 Groove nut wrench

<p>75029034000</p>	Description/example of use Tool for adjusting, removing and installing components with groove nuts Technical data Drive: 1/2 in Outside diameter: 22 mm (0.87 in) Length: 53 mm (2.09 in) used with model Naked Bike				
	Service	<input checked="" type="checkbox"/>	Repair	<input type="checkbox"/>	optional

90129022000 Groove nut wrench

<p>90129022000</p>	Description/example of use Tool for adjusting, removing and installing components with groove nuts Technical data Drive: 1/2 in Outside diameter: 43 mm (1.69 in) Length: 92 mm (3.62 in) used with model Naked Small				
	Service	<input type="checkbox"/>	Repair	<input checked="" type="checkbox"/>	optional

90129050100 Groove nut wrench

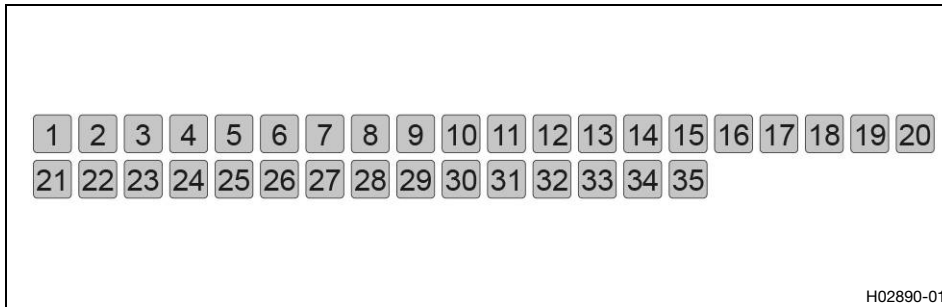

<p>90129050100</p>	Description/example of use Tool for adjusting, removing and installing components with groove nuts Technical data Drive: 1/2 in Outside diameter: 51 mm (2.01 in) Length: 60 mm (2.36 in) used with model Naked Small				
	Service	<input checked="" type="checkbox"/>	Repair	<input type="checkbox"/>	optional

14.1 Overview

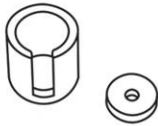
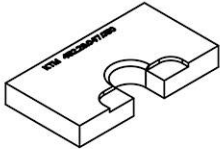

H02890-01

1	Insert for crankshaft pressing tool (45229008000) (p. 78)
2	Separator plate (45229047050) (p. 78)
3	Insert for crankshaft pressing tool (46229008000) (p. 78)
4	Anchor plate for crankshaft pressing tool (46229047002) (p. 78)
5	Separator plate (46229047050) (p. 79)
6	Insert for crankshaft pressing tool (47029008000) (p. 79)
7	Crankshaft pressing tool (47229047000) (p. 79)
8	Crankshaft pressing tool (50329047000) (p. 79)
9	Separator plate (50329047050) (p. 80)
10	Separator plate (50329047051) (p. 80)
11	Sleeve for crankshaft pressing tool (50429047001) (p. 80)
12	Cover for crankshaft pressing tool (50429047003) (p. 80)
13	Insert for crankshaft pressing tool (54829008000) (p. 81)
14	Separator plate (54829009000) (p. 81)
15	Insert for crankshaft pressing tool (54829108000) (p. 81)
16	Crankshaft pressing tool (75029047000) (p. 81)
17	Separator plate, upper part (75029047050) (p. 82)
18	Separator plate, base (75029047051) (p. 82)
19	Cover for crankshaft pressing tool (76629047003) (p. 82)
20	Insert for crankshaft pressing tool (77029008000) (p. 82)
21	Separator plate (77029009001) (p. 83)
22	Insert for crankshaft pressing tool (77229008000) (p. 83)
23	Separator plate (77229009000) (p. 83)
24	Separator plate (77229032000) (p. 84)
25	Insert for crankshaft pressing tool (77729008000) (p. 84)
26	Insert for crankshaft pressing tool (78029008000) (p. 84)
27	Separator plate (78029009100) (p. 84)
28	Insert for crankshaft pressing tool (78929008000) (p. 85)
29	Separator plate (78929009000) (p. 85)
30	Insert for crankshaft pressing tool (79029008000) (p. 85)
31	Separator plate (79029009000) (p. 85)
32	Insert for crankshaft pressing tool (79029108000) (p. 86)
33	Separator plate (79229009000) (p. 86)
34	Insert for crankshaft pressing tool (79429008000) (p. 86)
35	Separator plate (79429009000) (p. 87)

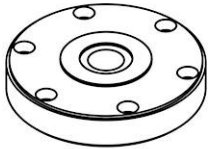
45229008000 Insert for crankshaft pressing tool			
 <p>45229008000</p>	Description/example of use Sleeve with cover used as insert in the pressing tool for pressing the crankshaft together		
	for use with 50329047000 used with model TC 50		
Service <input type="checkbox"/>		Repair <input type="checkbox"/>	
		optional <input checked="" type="checkbox"/>	
45229047050 Separator plate			
 <p>45229047050</p>	Description/example of use Tool for separating the crankshaft		
	used with model TC 50		
Service <input type="checkbox"/>		Repair <input type="checkbox"/>	
		optional <input checked="" type="checkbox"/>	
46229008000 Insert for crankshaft pressing tool			
 <p>46229008000</p>	Description/example of use Sleeve with cover used as insert in the pressing tool for pressing the crankshaft together		
	for use with 50329047000 used with model TC 65		
Service <input type="checkbox"/>		Repair <input type="checkbox"/>	
		optional <input checked="" type="checkbox"/>	
46229047002 Anchor plate for crankshaft pressing tool			
 <p>46229047002</p>	Description/example of use Anchor plate for screwing on to the pressing tool, for pressing the crankshaft together		
	for use with 50329047000 used with model TC 50 TC 65 TC 85 2014 TC 85 2015 TC 85 2016 TC 85 2017		
Service <input type="checkbox"/>		Repair <input type="checkbox"/>	
		optional <input checked="" type="checkbox"/>	

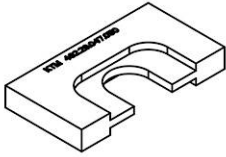
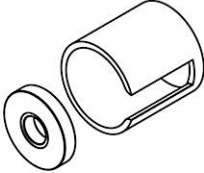
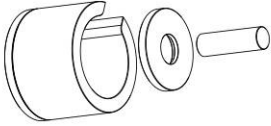
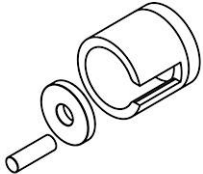
46229047050 Separator plate		
 <p>46229047050</p>	Description/example of use Tool for separating the crankshaft	
	used with model TC 65 TC 85	
Service	<input type="checkbox"/>	Repair
		optional
		<input checked="" type="checkbox"/>
47029008000 Insert for crankshaft pressing tool		
 <p>47029008000</p>	Description/example of use Sleeve with cover used as insert in the pressing tool for pressing the crankshaft together	
	used with model TC 85 2014 TC 85 2015 TC 85 2016 TC 85 2017	
		for use with
		50329047000
Service	<input type="checkbox"/>	Repair
		optional
		<input checked="" type="checkbox"/>
47229047000 Crankshaft pressing tool		
 <p>47229047000</p>	Description/example of use Tool for pressing the crankshaft together	
	used with model TC 85 2018	
Service	<input type="checkbox"/>	Repair
		optional
		<input checked="" type="checkbox"/>
50329047000 Crankshaft pressing tool		
 <p>50329047000</p>	Description/example of use Tool for pressing the crankshaft together	
	used with model TC 50 TC 65 TC 85 2014 TC 85 2015 TC 85 2016 TC 85 2017 MX2 2 stroke Enduro E1 2 stroke	
		matching tools / articles are
		45229008000
		46229008000
		46229047002
		47029008000
		50429047001
		54829008000
Service	<input type="checkbox"/>	Repair
		optional
		<input checked="" type="checkbox"/>

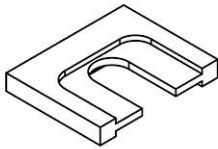
50329047050 Separator plate		
 <p>50329047050</p>	Description/example of use Tool for separating the crankshaft	
	used with model MX2 2 stroke TE 150 TX 125	
Service	<input type="checkbox"/>	Repair
		optional
		<input checked="" type="checkbox"/>

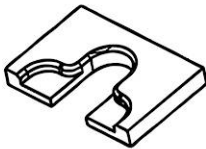
50329047051 Separator plate		
 <p>50329047051</p>	Description/example of use Tool for separating the crankshaft	
	used with model TE 125	
Service	<input type="checkbox"/>	Repair
		optional
		<input checked="" type="checkbox"/>

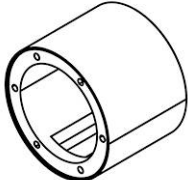
50429047001 Sleeve for crankshaft pressing tool		
 <p>50429047001</p>	Description/example of use Sleeve insert in the pressing tool for pressing the crankshaft together	
	for use with 50329047000 matching tools / articles are 50429047003	
used with model TC 125 2016 TC 125 2017 TC 125 2018 TE 150 TX 125		
Service	<input type="checkbox"/>	Repair
		optional
		<input checked="" type="checkbox"/>

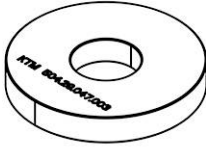
50429047003 Cover for crankshaft pressing tool		
 <p>50429047003</p>	Description/example of use Cover for sleeve, used as insert in the pressing tool for pressing the crankshaft together	
	for use with 50429047001	
used with model TC 125 2016 TC 125 2017 TC 125 2018 TE 150 TX 125		
Service	<input type="checkbox"/>	Repair
		optional
		<input checked="" type="checkbox"/>

54829008000 Insert for crankshaft pressing tool			
 <p>54829008000</p>	<p>Description/example of use</p> <p>Sleeve with cover used as insert in the pressing tool for pressing the crankshaft together</p>		
	<p>for use with</p> <p>50329047000</p> <p>used with model</p> <p>TC 250 2014</p> <p>TC 250 2015</p> <p>TC 250 2016</p> <p>TC 125 2014</p> <p>TC 125 2015</p>		
<p>Service <input type="checkbox"/></p>		<p>Repair <input type="checkbox"/></p>	<p>optional <input checked="" type="checkbox"/></p>

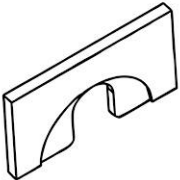
54829009000 Separator plate			
 <p>54829009000</p>	<p>Description/example of use</p> <p>Tool for separating the crankshaft</p>		
	<p>used with model</p> <p>MX1 2 stroke</p> <p>Enduro E2 2 stroke</p> <p>Enduro E3 2 stroke</p> <p>Cross Country E3</p>		
<p>Service <input type="checkbox"/></p>		<p>Repair <input type="checkbox"/></p>	<p>optional <input checked="" type="checkbox"/></p>

54829108000 Insert for crankshaft pressing tool			
 <p>54829108000</p>	<p>Description/example of use</p> <p>Sleeve with cover used as insert in the pressing tool for pressing the crankshaft together</p>		
	<p>for use with</p> <p>75029047000</p> <p>used with model</p> <p>TC 250 2017</p> <p>TC 250 2018</p> <p>TE 125</p> <p>TE 250 AU 2014</p> <p>TE 250 US 2014</p> <p>TE 250 2015</p> <p>TE 250 2016</p> <p>TE 250 2017</p> <p>TE 250 2018</p> <p>Enduro E3 2 stroke</p> <p>Cross Country E3</p>		
<p>Service <input type="checkbox"/></p>		<p>Repair <input type="checkbox"/></p>	<p>optional <input checked="" type="checkbox"/></p>

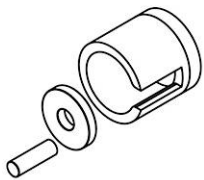
75029047000 Crankshaft pressing tool		
 <p>75029047000</p>	<p>Description/example of use</p> <p>Tool for pressing the crankshaft together</p>	
	<p>used with model</p> <p>MX1</p> <p>MX2 4 stroke</p> <p>Enduro E1 4 stroke</p> <p>TE 250 AU 2014</p> <p>TE 250 US 2014</p>	<p>matching tools / articles are</p> <p>54829108000</p> <p>76629047003</p> <p>77029008000</p> <p>77229008000</p> <p>77729008000</p>

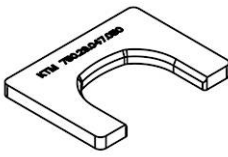

75029047000 Crankshaft pressing tool		
	TE 250 2015	78029008000
	TE 250 2016	78929008000
	TE 250 2017	79029008000
	TE 250 2018	79029108000
	Enduro E2 4 stroke	79429008000
	Enduro E3	
	Cross Country	
	Supermoto	
	Street Enduro	
	Naked Mid	
Service	<input type="checkbox"/>	Repair <input type="checkbox"/> optional <input checked="" type="checkbox"/>

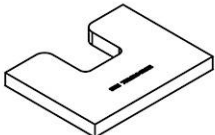
75029047050 Separator plate, upper part		
 <p>75029047050</p>	Description/example of use	
	Tool for separating the crankshaft	
	for use with	
	75029047051	
	matching tools / articles are	
used with model		75029047051
Supermoto / Dual Sport		
Street Enduro		
Naked Mid		
Service	<input type="checkbox"/>	Repair <input type="checkbox"/> optional <input checked="" type="checkbox"/>

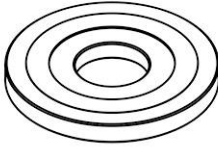
75029047051 Separator plate, base		
 <p>75029047051</p>	Description/example of use	
	Tool for separating the crankshaft	
	for use with	
	75029047050	
	matching tools / articles are	
used with model		75029047050
Supermoto / Dual Sport		
Street Enduro		
Naked Mid		
Service	<input type="checkbox"/>	Repair <input type="checkbox"/> optional <input checked="" type="checkbox"/>

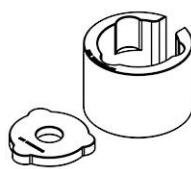
76629047003 Cover for crankshaft pressing tool		
 <p>76629047003</p>	Description/example of use	
	Cover for pressing tool for pressing the crankshaft together	
	for use with	
	75029047000	
	used with model	
Naked Mid		
Service	<input type="checkbox"/>	Repair <input type="checkbox"/> optional <input checked="" type="checkbox"/>

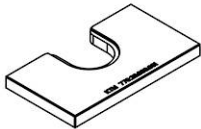
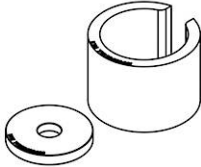
77029008000 Insert for crankshaft pressing tool		
 <p>77029008000</p>	Description/example of use	
	Sleeve with cover used as insert in the pressing tool for pressing the crankshaft together	
	for use with	
	75029047000	
	used with model	

77029008000 Insert for crankshaft pressing tool			
	FE 250 2014 FE 250 2015 FE 250 2016		
	Service <input type="checkbox"/>	Repair <input type="checkbox"/>	optional <input checked="" type="checkbox"/>
77029009001 Separator plate			
 <p>77029009001</p>	Description/example of use Tool for separating the crankshaft		
	used with model FC 250 2014 FC 250 2015 FE 250 2014 FE 250 2015 FE 250 2016		
	Service <input type="checkbox"/>	Repair <input type="checkbox"/>	optional <input checked="" type="checkbox"/>
77229008000 Insert for crankshaft pressing tool			
 <p>77229008000</p>	Description/example of use Sleeve with cover used as insert in the pressing tool for pressing the crankshaft together		
	used with model FC 350 2014 FC 350 2015 FC 350 2017 FC 350 2018 FE 350 FE 350 S FX 350		
	Service <input type="checkbox"/>	Repair <input type="checkbox"/>	optional <input checked="" type="checkbox"/>
77229009000 Separator plate			
 <p>77229009000</p>	Description/example of use Tool for separating the crankshaft		
	used with model FC 350 2014 FC 350 2015 FE 350 2014 FE 350 2015 FE 350 2016 FE 350 S 2015 FE 350 S 2016		
	Service <input type="checkbox"/>	Repair <input type="checkbox"/>	optional <input checked="" type="checkbox"/>

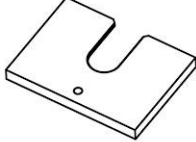
77229032000 Separator plate		
 <p>77229032000</p>	<p>Description/example of use</p> <p>Tool for pressing out balancer shaft drive gear wheel</p>	
	<p>used with model</p> <p>FC 350</p> <p>MX2 4 stroke</p> <p>Enduro E1 4 stroke</p> <p>FE 350</p> <p>FE 350 S</p> <p>FX 350</p>	
Service	<input type="checkbox"/>	Repair
	<input type="checkbox"/>	optional
		<input checked="" type="checkbox"/>

77729008000 Insert for crankshaft pressing tool		
 <p>77729008000</p>	<p>Description/example of use</p> <p>Sleeve with cover used as insert in the pressing tool for pressing the crankshaft together</p>	
	<p>used with model</p> <p>FC 250 2014</p> <p>FC 250 2015</p>	
		for use with
		75029047000
Service	<input type="checkbox"/>	Repair
	<input type="checkbox"/>	optional
		<input checked="" type="checkbox"/>

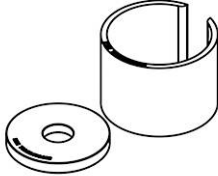
78029008000 Insert for crankshaft pressing tool		
 <p>78029008000</p>	<p>Description/example of use</p> <p>Sleeve with cover used as insert in the pressing tool for pressing the crankshaft together</p>	
	<p>used with model</p> <p>FE 450 2014</p> <p>FE 450 2015</p> <p>FE 450 2016</p> <p>FE 501 2014</p> <p>FE 501 2015</p> <p>FE 501 2016</p> <p>FE 501 S 2015</p> <p>FE 501 S 2016</p>	
		for use with
		75029047000
Service	<input type="checkbox"/>	Repair
	<input type="checkbox"/>	optional
		<input checked="" type="checkbox"/>

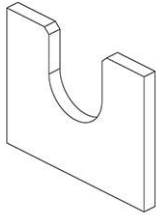
78029009100 Separator plate		
 <p>78029009100</p>	<p>Description/example of use</p> <p>Tool for separating the crankshaft</p>	
	<p>used with model</p> <p>FE 450 2014</p> <p>FE 450 2015</p> <p>FE 450 2016</p> <p>FE 501 2014</p> <p>FE 501 2015</p> <p>FE 501 2016</p> <p>FE 501 S 2015</p> <p>FE 501 S 2016</p>	
Service	<input type="checkbox"/>	Repair
	<input type="checkbox"/>	optional
		<input checked="" type="checkbox"/>

78929008000 Insert for crankshaft pressing tool		
 <p>78929008000</p>	<p>Description/example of use</p> <p>Sleeve with cover used as insert in the pressing tool for pressing the crankshaft together</p>	
	<p>for use with</p> <p>75029047000</p> <p>used with model</p> <p>FC 450</p> <p>FE 450 2017</p> <p>FE 450 2018</p> <p>FE 501 2017</p> <p>FE 501 2018</p> <p>FE 501 S 2017</p> <p>FE 501 S 2018</p> <p>FX 450</p> <p>Supermoto Competition</p>	
Service	<input type="checkbox"/>	Repair
	<input type="checkbox"/>	optional
		<input checked="" type="checkbox"/>

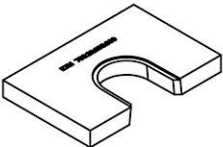
78929009000 Separator plate		
 <p>78929009000</p>	<p>Description/example of use</p> <p>Tool for separating the crankshaft</p>	
	<p>used with model</p> <p>FC 450 2014</p> <p>FC 450 2015</p> <p>FS 450 2015</p>	
Service	<input type="checkbox"/>	Repair
	<input type="checkbox"/>	optional
		<input checked="" type="checkbox"/>

79029008000 Insert for crankshaft pressing tool		
 <p>79029008000</p>	<p>Description/example of use</p> <p>Sleeve with cover used as insert in the pressing tool for pressing the crankshaft together</p>	
	<p>for use with</p> <p>75029047000</p> <p>used with model</p> <p>FC 350 2016</p> <p>FC 350 2017</p> <p>FC 350 2018</p> <p>FC 250 2016</p> <p>FC 250 2017</p> <p>FC 250 2018</p> <p>FX 350</p>	
Service	<input type="checkbox"/>	Repair
	<input type="checkbox"/>	optional
		<input checked="" type="checkbox"/>

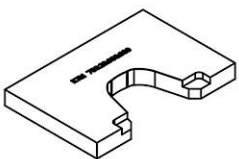
79029009000 Separator plate		
 <p>79029009000</p>	<p>Description/example of use</p> <p>Tool for separating the crankshaft</p>	
	<p>used with model</p> <p>FC 250 2016</p> <p>FC 250 2017</p> <p>FC 250 2018</p> <p>FE 250 2017</p> <p>FE 250 2018</p>	

79029009000 Separator plate					
	FE 450 2017 FE 450 2018 FE 501 2017 FE 501 2018 FE 501 S 2017 FE 501 S 2018				
	Service	<input type="checkbox"/>	Repair	<input type="checkbox"/>	optional

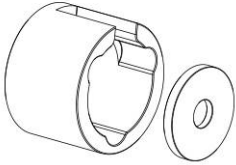
79029108000 Insert for crankshaft pressing tool					
 <p>79029108000</p>	Description/example of use Sleeve with cover used as insert in the pressing tool for pressing the crankshaft together				
	for use with 75029047000 used with model FE 250 2017 FE 250 2018				
Service	<input type="checkbox"/>	Repair	<input type="checkbox"/>	optional	<input checked="" type="checkbox"/>

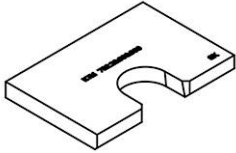
79229009000 Separator plate					
 <p>79229009000</p>	Description/example of use Tool for separating the crankshaft				
	used with model FC 350 2016 FC 350 2017 FC 350 2018 FE 350 2017 FE 350 2018 FE 350 S 2017 FE 350 S 2018 FX 350				
Service	<input type="checkbox"/>	Repair	<input type="checkbox"/>	optional	<input checked="" type="checkbox"/>

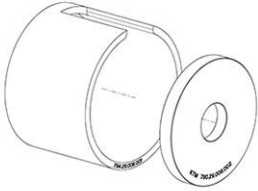
79429008000 Insert for crankshaft pressing tool					
 <p>79428008000</p>	Description/example of use Sleeve with cover used as insert in the pressing tool for pressing the crankshaft together				
	for use with 75029047000 used with model FC 450 2017 FC 450 2018 FE 450 2017 FE 450 2018 FE 501 2017 FE 501 2018 FE 501 S 2017 FE 501 S 2018 FX 450 FS 450 2016 FS 450 2017 FS 450 2018				
Service	<input type="checkbox"/>	Repair	<input type="checkbox"/>	optional	<input checked="" type="checkbox"/>

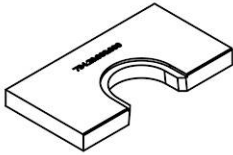
79429009000 Separator plate			
 <p>79429009000</p>	<p>Description/example of use</p> <p>Tool for separating the crankshaft</p>		
	<p>used with model</p> <p>FC 450 2016</p> <p>FC 450 2017</p> <p>FC 450 2018</p> <p>FX 450</p> <p>FS 450 2016</p> <p>FS 450 2017</p> <p>FS 450 2018</p>		
Service	<input type="checkbox"/>	Repair	<input type="checkbox"/>
		optional	<input checked="" type="checkbox"/>

15.1 Wall tool organizer overview

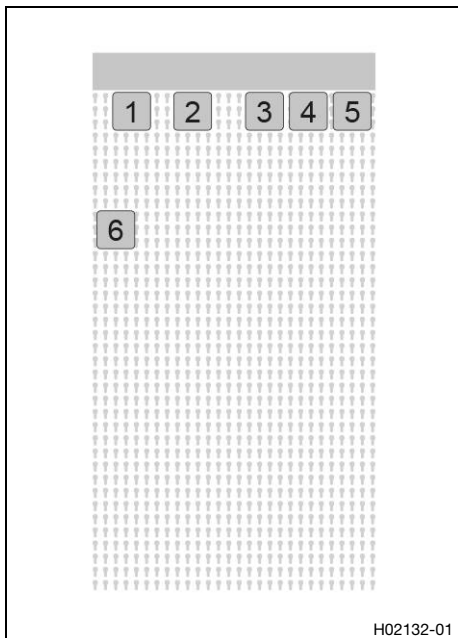

1	Piston ring compressor (60029015000) (📖 p. 88)
2	Piston assembly ring (75029015102) (📖 p. 88)
3	Insertion for piston ring lock (75029035000) (📖 p. 89)
4	Insertion for piston ring lock (77229030000) (📖 p. 89)
5	Insertion for piston ring lock (77329030100) (📖 p. 89)
6	Insertion for piston ring lock (77729030100) (📖 p. 89)

60029015000 Piston ring compressor



60029015000

Description/example of use

Tool for tensioning piston rings when installing the piston in the cylinder

Technical data

Height: 80 mm (3.15 in)

Diameter: 57 ... 125 mm (2.24 ... 4.92 in)

used with model

MX1 4 stroke

MX2 4 stroke

Enduro E1 4 stroke

Enduro E2 4 stroke

Enduro E3 4 stroke

Cross Country E2

Supermoto Competition

Naked Bike

Service	<input type="checkbox"/>	Repair	<input checked="" type="checkbox"/>	optional	<input type="checkbox"/>
---------	--------------------------	--------	-------------------------------------	----------	--------------------------

75029015102 Piston assembly ring



75029015102

Description/example of use

Tool for installing the piston in the cylinder

Technical data

Height: 45 mm (1.77 in)

Diameter: 102 mm (4.02 in)

used with model

701 Supermoto 2016

701 Enduro 2016

Service	<input type="checkbox"/>	Repair	<input checked="" type="checkbox"/>	optional	<input type="checkbox"/>
---------	--------------------------	--------	-------------------------------------	----------	--------------------------

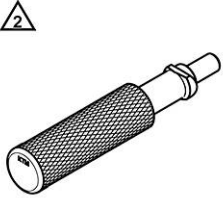
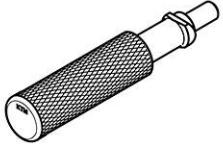
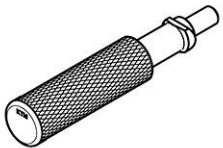
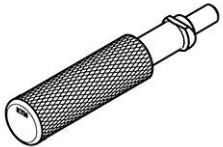
75029035000 Insertion for piston ring lock			
 <p>75029035000</p>	Description/example of use Tool for installing the piston ring lock in the piston		
	used with model Supermoto / Dual Sport Street Enduro Naked Mid		
	Service <input type="checkbox"/>	Repair <input checked="" type="checkbox"/>	optional <input type="checkbox"/>
77229030000 Insertion for piston ring lock			
 <p>77229030000</p>	Description/example of use Tool for installing the piston ring lock in the piston		
	used with model FC 350 FE 350 FE 350 S FX 350		
	Service <input type="checkbox"/>	Repair <input checked="" type="checkbox"/>	optional <input type="checkbox"/>
77329030100 Insertion for piston ring lock			
 <p>77329030100</p>	Description/example of use Tool for installing the piston ring lock in the piston		
	used with model FC 450 FE 450 Enduro E3 4 stroke FX 450 Supermoto Competition Naked Small		
	Service <input type="checkbox"/>	Repair <input checked="" type="checkbox"/>	optional <input type="checkbox"/>
77729030100 Insertion for piston ring lock			
 <p>77729030100</p>	Description/example of use Tool for installing the piston ring lock in the piston		
	used with model MX2 4 stroke Enduro E1 4 stroke		
	Service <input type="checkbox"/>	Repair <input checked="" type="checkbox"/>	optional <input type="checkbox"/>

16.1 Wall tool organizer overview

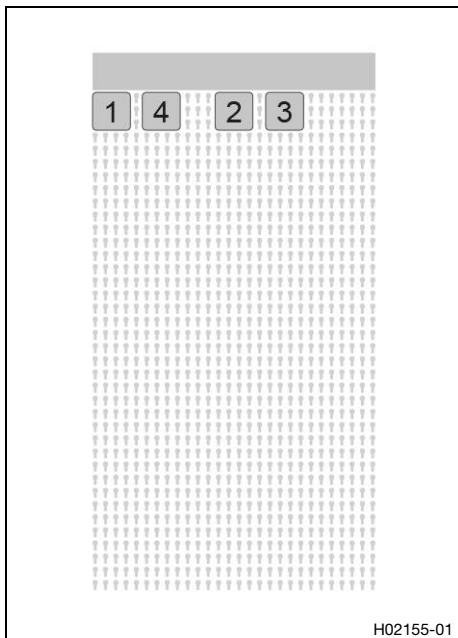

- | | |
|---|---|
| 1 | Mounting tool for lock ring (75029005000) (📖 p. 90) |
| 2 | Assembly screws (75029033000) (📖 p. 90) |
| 3 | Mounting tool for lock ring (76629032000) (📖 p. 90) |
| 4 | Mounting tool for lock ring (79029005000) (📖 p. 91) |

75029005000 Mounting tool for lock ring

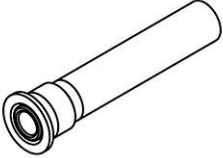
 <p>75029005000</p>	Description/example of use Tool for mounting lock rings on the drive and countershaft		
	used with model FC 250 2016 FC 250 2017 FC 250 2018 701 Supermoto 2016 701 Enduro 2016		
Service	<input type="checkbox"/>	Repair	<input checked="" type="checkbox"/>
		optional	<input type="checkbox"/>

75029033000 Assembly screws

 <p>75029033000</p>	Description/example of use 4 screws for tensioning the slipper clutch		
	used with model Supermoto / Dual Sport FS 450 2015 FS 450 2016 FS 450 2017 Street Enduro Naked Mid		
Service	<input type="checkbox"/>	Repair	<input checked="" type="checkbox"/>
		optional	<input type="checkbox"/>

76629032000 Mounting tool for lock ring

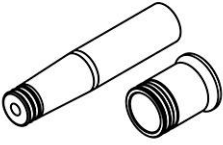
 <p>76629032000</p>	Description/example of use Tool for mounting lock rings on the countershaft and main shaft		
	used with model 701 Supermoto 2017 701 Supermoto 2018		

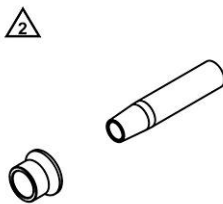
76629032000 Mounting tool for lock ring			
	701 Enduro 2017 701 Enduro 2018 Naked Mid		
	Service <input type="checkbox"/>	Repair <input checked="" type="checkbox"/>	optional <input type="checkbox"/>
79029005000 Mounting tool for lock ring			
 <p>79029005000</p>	Description/example of use Tool for mounting lock ring on the main shaft used with model FC 250 2016 FC 250 2017 FC 250 2018		
	Service <input type="checkbox"/>	Repair <input checked="" type="checkbox"/>	optional <input type="checkbox"/>

17.1 Overview

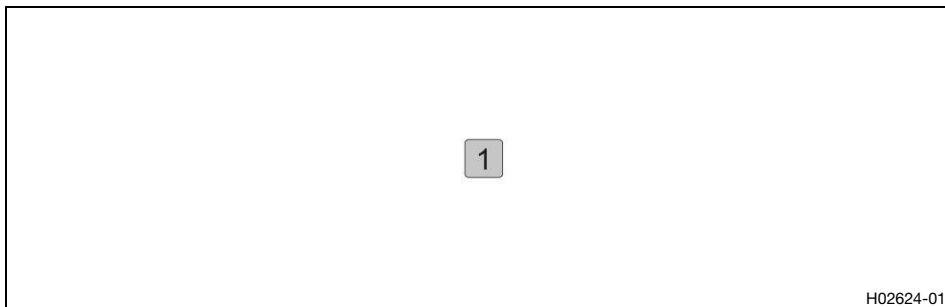

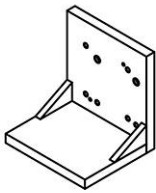

1 Clamping plate (75029050000) (📖 p. 92)

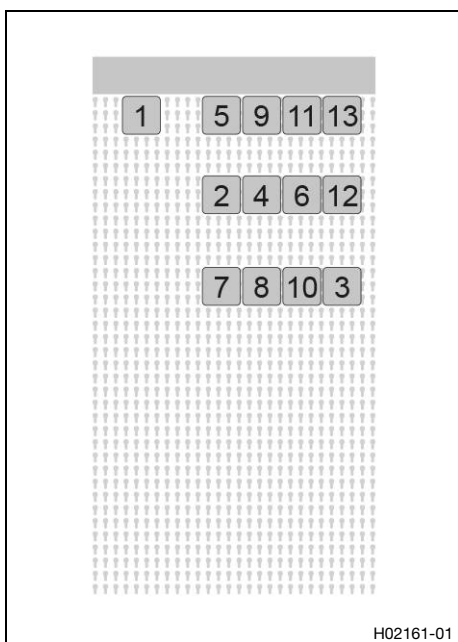

75029050000 Clamping plate		
 <p>75029050000</p>	<p>Description/example of use</p> <p>Plate for mounting the cylinder head</p>	
	<p>used with model</p> <p>FC 450</p> <p>FE 450</p> <p>Enduro E3 4 stroke</p> <p>FX 450</p> <p>Supermoto</p> <p>Street Enduro</p> <p>Naked Mid</p>	
Service	<input type="checkbox"/>	Repair <input checked="" type="checkbox"/> optional <input type="checkbox"/>

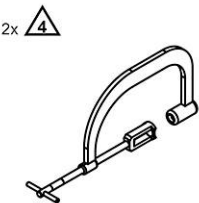

17.2 Wall tool organizer overview



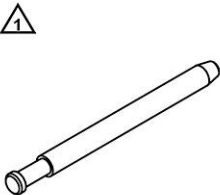

1	Valve spring mouter (59029019000) (📖 p. 93)
2	Limit plug gauge (59029026006) (📖 p. 93)
3	Release device for timing chain tensioner (61229021000) (📖 p. 93)
4	Limit plug gauge (77029026000) (📖 p. 93)
5	Insert for valve spring lever (77029041200) (📖 p. 94)
6	Limit plug gauge (77229026000) (📖 p. 94)
7	Insert for timing chain tensioner (77229035000) (📖 p. 94)
8	Adjustment bush bridge (77229050044) (📖 p. 95)
9	Insert for valve spring lever (77229060000) (📖 p. 95)
10	Release device for timing chain tensioner (77329051000) (📖 p. 95)
11	Insert for valve spring lever (78029060000) (📖 p. 95)
12	Locking screw (78129032000) (📖 p. 96)
13	Insert for valve spring lever (79029060000) (📖 p. 96)

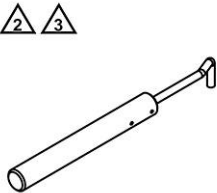
59029019000 Valve spring mounter		
 <p>2x </p> <p>59029019000</p>	Description/example of use Tool for installing and removing valves and valve springs	
	used with model MX1 4 stroke MX2 4 stroke Enduro E1 4 stroke Enduro E2 4 stroke Enduro E3 4 stroke Cross Country E2 Street	matching tools / articles are 77029041200 77229060000 78029060000 79029060000
Service <input type="checkbox"/>	Repair <input checked="" type="checkbox"/>	optional <input type="checkbox"/>

59029026006 Limit plug gauge		
 <p></p> <p>59029026006</p>	Description/example of use Tool for checking valve guides	
	Technical data Diameter: 6.05 mm (0.2382 in) used with model FC 450 FE 450 Enduro E3 4 stroke FX 450 Supermoto Street Enduro Naked Mid	
Service <input type="checkbox"/>	Repair <input checked="" type="checkbox"/>	optional <input type="checkbox"/>

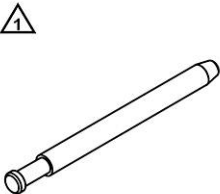
61229021000 Release device for timing chain tensioner		
 <p> </p> <p>61229021000</p>	Description/example of use Tool for installing timing chain tensioner	
	used with model FC 350 MX2 4 stroke Enduro E1 4 stroke FE 350 FE 350 S FX 350	
Service <input checked="" type="checkbox"/>	Repair <input type="checkbox"/>	optional <input type="checkbox"/>

77029026000 Limit plug gauge		
 <p></p> <p>77029026000</p>	Description/example of use Tool for checking valve guides	
	Technical data Diameter: 5.05 mm (0.1988 in) used with model FE 450 2014 FE 450 2015 FE 450 2016 FE 501 2014 FE 501 2015 FE 501 2016	

77029026000 Limit plug gauge					
	FE 501 S 2015 FE 501 S 2016 Naked Small				
	Service	<input type="checkbox"/>	Repair	<input checked="" type="checkbox"/>	optional

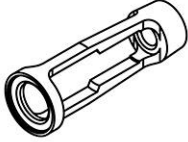
77029041200 Insert for valve spring lever					
 <p>77029041200</p>	Description/example of use Tool for installing and removing valves and valve springs for use with 59029019000 used with model FC 450 FC 250 2016 FC 250 2017 FC 250 2018 FE 250 2017 FE 250 2018 FE 450 Enduro E3 4 stroke FX 450 Supermoto Competition Naked Small				
	Service	<input type="checkbox"/>	Repair	<input checked="" type="checkbox"/>	optional

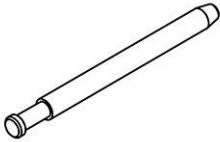
77229026000 Limit plug gauge					
 <p>77229026000</p>	Description/example of use Tool for checking valve guides Technical data Diameter: 5.55 mm (0.2185 in) used with model FC 350 MX2 4 stroke Enduro E1 4 stroke FE 350 FE 350 S FX 350				
	Service	<input type="checkbox"/>	Repair	<input checked="" type="checkbox"/>	optional

77229035000 Insert for timing chain tensioner					
 <p>77229035000</p>	Description/example of use Tool for tensioning timing chain used with model FC 350 2014 FC 350 2015 FE 350 2014 FE 350 2015 FE 350 2016 FE 350 S 2015 FE 350 S 2016				
	Service	<input checked="" type="checkbox"/>	Repair	<input type="checkbox"/>	optional

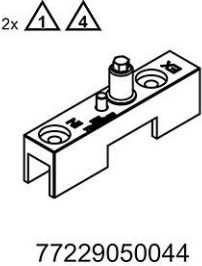
77229050044 Adjustment bush bridge			
 <p>77229050044</p>	<p>Description/example of use</p> <p>Tool for working on camshaft (changing camshaft bearing, checking and adjusting valve timing)</p>		
	<p>used with model</p> <p>FC 350 FE 350 2014 FE 350 2015 FE 350 2016 FE 350 S 2015 FE 350 S 2016 FX 350</p>		
Service	<input checked="" type="checkbox"/>	Repair	<input type="checkbox"/>
		optional	<input type="checkbox"/>

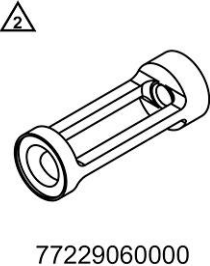
77229060000 Insert for valve spring lever			
 <p>77229060000</p>	<p>Description/example of use</p> <p>Tool for installing and removing valves and valve springs</p>		
	<p>for use with</p> <p>59029019000</p> <p>used with model</p> <p>FC 350 2014 FC 350 2015 FC 250 2014 FC 250 2015 FE 250 2014 FE 250 2015 FE 250 2016 FE 350 2014 FE 350 2015 FE 350 2016 FE 350 S 2015 FE 350 S 2016</p>		
Service	<input type="checkbox"/>	Repair	<input checked="" type="checkbox"/>
		optional	<input type="checkbox"/>

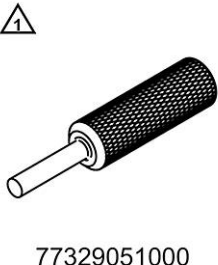
77329051000 Release device for timing chain tensioner			
 <p>77329051000</p>	<p>Description/example of use</p> <p>Tool for installing timing chain tensioner</p>		
	<p>used with model</p> <p>Supermoto / Dual Sport Street Enduro Naked Mid</p>		
Service	<input checked="" type="checkbox"/>	Repair	<input type="checkbox"/>
		optional	<input type="checkbox"/>

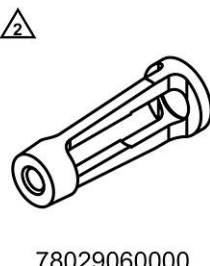
78029060000 Insert for valve spring lever			
 <p>78029060000</p>	<p>Description/example of use</p> <p>Tool for installing and removing valves and valve springs</p>		
	<p>for use with</p> <p>59029019000</p> <p>used with model</p> <p>701 Supermoto 2016 701 Enduro 2016</p>		
Service	<input type="checkbox"/>	Repair	<input checked="" type="checkbox"/>
		optional	<input type="checkbox"/>

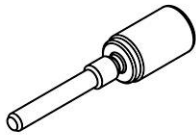

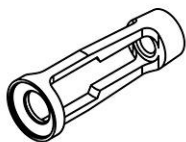
78129032000 Locking screw		
 <p>78129032000</p>	Description/example of use Tool for positioning the balancer shaft (installing clutch cover)	
	used with model FC 450 FE 450 Enduro E3 4 stroke FX 450 Supermoto Competition	
Service	<input checked="" type="checkbox"/>	Repair <input type="checkbox"/> optional <input type="checkbox"/>

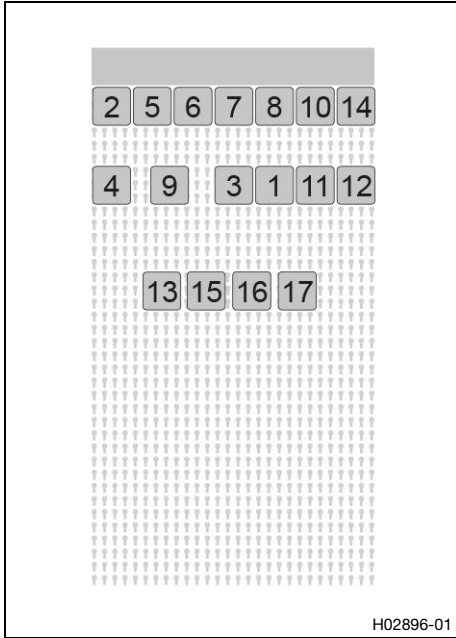

79029060000 Insert for valve spring lever		
 <p>79029060000</p>	Description/example of use Tool for installing and removing valves and valve springs	
	for use with 59029019000 used with model FC 350 2016 FC 350 2017 FC 350 2018 FC 250 2016 FC 250 2017 FC 250 2018 FE 250 2017 FE 250 2018 FE 350 2017 FE 350 2018 FE 350 S 2017 FE 350 S 2018 FX 350 701 Supermoto 2017 701 Supermoto 2018 701 Enduro 2017 701 Enduro 2018 Naked Mid	
Service	<input type="checkbox"/>	Repair <input checked="" type="checkbox"/> optional <input type="checkbox"/>



18.1 Wall tool organizer overview





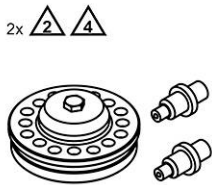

1	Pressing tool (47229005000) (📖 p. 97)
2	Pressing tool (50429005000) (📖 p. 97)
3	Pressing tool (54629027000) (📖 p. 98)
4	Tool bracket (58429089000) (📖 p. 98)
5	Pressing tool (58429091000) (📖 p. 98)
6	Pressing tool (58429092000) (📖 p. 98)
7	Pressing tool (60029043040) (📖 p. 99)
8	Pressing tool (75029044010) (📖 p. 99)
9	Pressing tool (75029044020) (📖 p. 100)
10	Pressing tool (75029051000) (📖 p. 100)
11	Pressing tool (76629044011) (📖 p. 100)
12	Pressing tool (76629044020) (📖 p. 101)
13	Pressing tool (76629044030) (📖 p. 101)
14	Pressing tool (79429006000) (📖 p. 101)
15	Pressing tool (90129020000) (📖 p. 101)
16	Pressing tool (90129056000) (📖 p. 102)
17	Pressing tool (93829043000) (📖 p. 102)

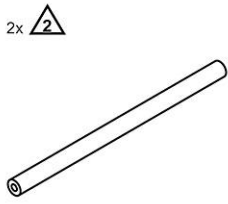

47229005000 Pressing tool			
  47229005000	Description/example of use Tool for pressing components in and out (shaft seal ring of crankshaft)		
	used with model TC 85 2018		
Service	<input type="checkbox"/>	Repair	<input checked="" type="checkbox"/>
		optional	<input type="checkbox"/>

50429005000 Pressing tool			
  50429005000	Description/example of use Tool for pressing components in and out (shaft seal ring of crankshaft)		
	used with model TC 250 2017 TC 250 2018 TC 125 2016 TC 125 2017 TC 125 2018 TE 150 TX 125 TE 250 2017 TE 250 2018 TE 300 2017 TE 300 2018 Cross Country E3		
Service	<input type="checkbox"/>	Repair	<input checked="" type="checkbox"/>
		optional	<input type="checkbox"/>

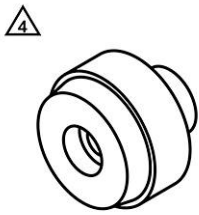
54629027000 Pressing tool		
 <p>2x  </p> <p>54629027000</p>	<p>Description/example of use</p> <p>Tool for pressing in components (clutch rivets on clutch basket)</p>	
	<p>used with model</p> <p>TC 125 2014</p> <p>TC 125 2015</p> <p>TE 125</p>	
Service	<input type="checkbox"/>	Repair <input checked="" type="checkbox"/> optional <input type="checkbox"/>

58429089000 Tool bracket		
 <p>2x </p> <p>58429089000</p>	<p>Description/example of use</p> <p>Tool for pressing components in and out (bearing rings when changing steering head bearing)</p>	
	<p>used with model</p> <p>MX</p> <p>Enduro E1</p> <p>Enduro E2</p> <p>Enduro E3</p> <p>Cross Country</p> <p>Supermoto</p> <p>Street Enduro</p> <p>Naked Mid</p>	
Service	<input type="checkbox"/>	Repair <input checked="" type="checkbox"/> optional <input type="checkbox"/>

58429091000 Pressing tool		
 <p></p> <p>58429091000</p>	<p>Description/example of use</p> <p>Tool for pressing components in (bearing rings when changing steering head bearing)</p>	
	<p>used with model</p> <p>MX</p> <p>Enduro E1</p> <p>Enduro E2</p> <p>Enduro E3</p> <p>Cross Country</p> <p>Supermoto</p> <p>Street Enduro</p> <p>Naked Mid</p>	
Service	<input type="checkbox"/>	Repair <input checked="" type="checkbox"/> optional <input type="checkbox"/>

58429092000 Pressing tool		
 <p></p> <p>58429092000</p>	<p>Description/example of use</p> <p>Tool for pressing components out (bearing rings when changing steering head bearing)</p>	
	<p>used with model</p> <p>MX</p> <p>Enduro E1</p> <p>Enduro E2</p> <p>Enduro E3</p> <p>Cross Country</p>	
Service	<input type="checkbox"/>	Repair <input checked="" type="checkbox"/> optional <input type="checkbox"/>

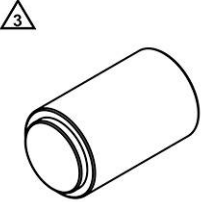
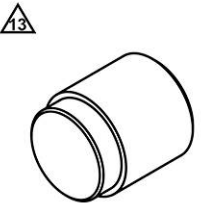
58429092000 Pressing tool			
	Supermoto Street Enduro Naked Mid		
	Service <input type="checkbox"/>	Repair <input checked="" type="checkbox"/>	optional <input type="checkbox"/>
60029043040 Pressing tool			
 <p>60029043040</p>	Description/example of use Tool for pressing components in (water pump shaft seal ring)		
	used with model FC 450 2016 FC 450 2017 FC 450 2018 FE 450 2017 FE 450 2018 FE 501 2017 FE 501 2018 FE 501 S 2017 FE 501 S 2018 FX 450 FS 450 2016 FS 450 2017 FS 450 2018		
	Service <input type="checkbox"/>	Repair <input checked="" type="checkbox"/>	optional <input type="checkbox"/>
75029044010 Pressing tool			
 <p>75029044010</p>	Description/example of use Tool for pressing components in (large camshaft bearing)		
	used with model TC 250 2017 TC 250 2018 FC 450 TE 250 2017 TE 250 2018 FE 450 TE 300 2017 TE 300 2018 Enduro E3 4 stroke FX 450 Cross Country E3 701 Supermoto 2016 Supermoto Competition 701 Enduro 2016		
	Service <input type="checkbox"/>	Repair <input checked="" type="checkbox"/>	optional <input type="checkbox"/>

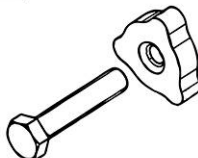
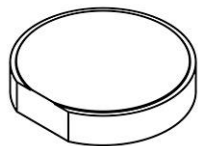
75029044020 Pressing tool			
 <p>75029044020</p>	<p>Description/example of use</p> <p>Tool for pressing components in (small camshaft bearing)</p>		
	<p>used with model</p> <p>TC 250 2017 TC 250 2018 FC 450 TE 250 2017 TE 250 2018 FE 450 TE 300 2017 TE 300 2018 Enduro E3 4 stroke FX 450 Cross Country E3 701 Supermoto 2016 Supermoto Competition 701 Enduro 2016</p>		
	Service <input type="checkbox"/>	Repair <input checked="" type="checkbox"/>	optional <input type="checkbox"/>
75029051000 Pressing tool			
 <p>75029051000</p>	<p>Description/example of use</p> <p>Tool for pressing components out (large camshaft bearing)</p>		
	<p>used with model</p> <p>TC 250 2017 TC 250 2018 FC 450 TE 250 2017 TE 250 2018 FE 450 TE 300 2017 TE 300 2018 Enduro E3 4 stroke FX 450 Cross Country E3 701 Supermoto 2016 Supermoto Competition 701 Enduro 2016</p>		
	Service <input type="checkbox"/>	Repair <input checked="" type="checkbox"/>	optional <input type="checkbox"/>
76629044011 Pressing tool			
 <p>76629044011</p>	<p>Description/example of use</p> <p>Tool for pressing components in (balancer shaft bearing, camshaft bearing)</p>		
	<p>used with model</p> <p>701 Supermoto 2017 701 Supermoto 2018 701 Enduro 2017 701 Enduro 2018 Naked Mid</p>		
	Service <input type="checkbox"/>	Repair <input checked="" type="checkbox"/>	optional <input type="checkbox"/>

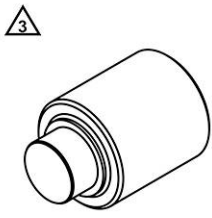

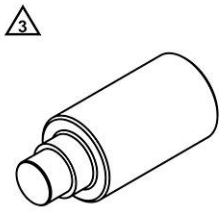
76629044020 Pressing tool			
 <p>76629044020</p>	Description/example of use Tool for pressing components in (balancer shaft bearing)		
	used with model 701 Supermoto 2017 701 Supermoto 2018 701 Enduro 2017 701 Enduro 2018 Naked Mid		
Service	<input type="checkbox"/>	Repair	<input checked="" type="checkbox"/>
		optional	<input type="checkbox"/>

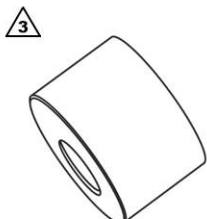
76629044030 Pressing tool			
 <p>76629044030</p>	Description/example of use Tool for pressing components in (camshaft bearing)		
	used with model 701 Supermoto 2017 701 Supermoto 2018 701 Enduro 2017 701 Enduro 2018 Naked Mid		
Service	<input type="checkbox"/>	Repair	<input checked="" type="checkbox"/>
		optional	<input type="checkbox"/>

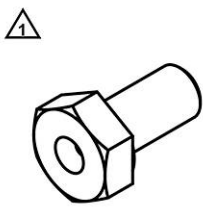
79429006000 Pressing tool			
 <p>79429006000</p>	Description/example of use Tool for pressing components in (water pump shaft bearing)		
	used with model FC 450 2016 FC 450 2017 FC 450 2018 FE 450 2017 FE 450 2018 FE 501 2017 FE 501 2018 FE 501 S 2017 FE 501 S 2018 FX 450 FS 450 2016 FS 450 2017 FS 450 2018		
Service	<input type="checkbox"/>	Repair	<input checked="" type="checkbox"/>
		optional	<input type="checkbox"/>

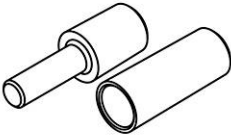
90129020000 Pressing tool			
 <p>90129020000</p>	Description/example of use Tool for removing components (rotor, engine case, main bearing)		
	used with model Naked Small		
Service	<input type="checkbox"/>	Repair	<input checked="" type="checkbox"/>
		optional	<input type="checkbox"/>

90129056000 Pressing tool					
<p>2x </p>  <p>90129056000</p>	<p>Description/example of use</p> <p>Tool for pressing components out (balancer shaft bearing)</p> <p>used with model</p> <p>Naked Small</p>				
	Service	<input type="checkbox"/>	Repair	<input checked="" type="checkbox"/>	optional

93829043000 Pressing tool					
<p></p>  <p>93829043000</p>	<p>Description/example of use</p> <p>Tool for pressing components in (shaft seal ring)</p> <p>used with model</p> <p>Naked Small</p>				
	Service	<input type="checkbox"/>	Repair	<input checked="" type="checkbox"/>	optional

19.1 Overview

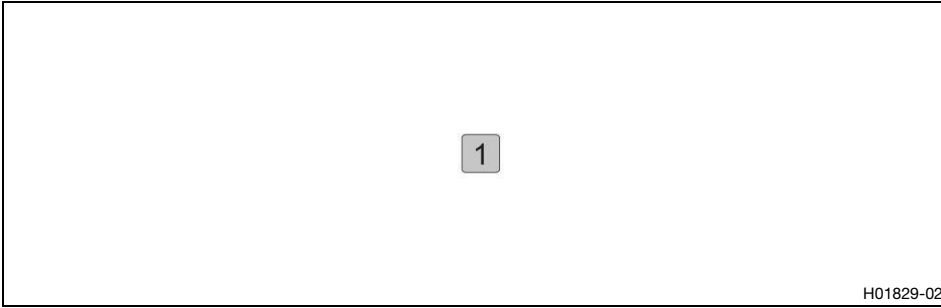

1 Spring hook (5030501700004) (📖 p. 103)

5030501700004 Spring hook

	Description/example of use Tool for removing exhaust springs		
	used with model Mini MX Enduro E1 Enduro E2 Enduro E3 Cross Country Supermoto Competition		
Service	<input checked="" type="checkbox"/>	Repair	<input type="checkbox"/>
		optional	<input type="checkbox"/>

19.2 Wall tool organizer overview

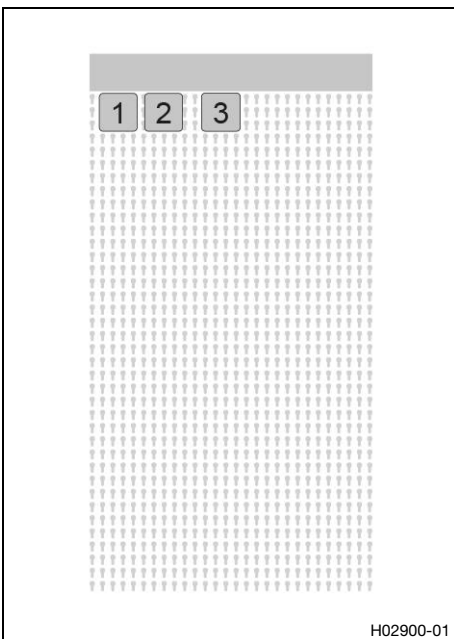

- | | |
|---|---|
| 1 | Syringe (50329050000) (📖 p. 104) |
| 2 | Chain rivet tool (60029020000) (📖 p. 104) |
| 3 | Mounting tool (79129081000) (📖 p. 104) |

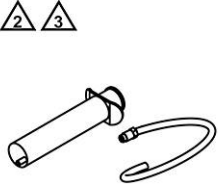
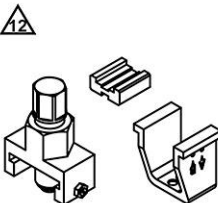
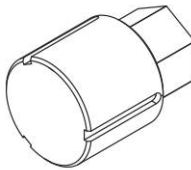
5032905000 Syringe			
 <p>5032905000</p>	Description/example of use Tool for extracting and adding liquids		
	used with model Husqvarna		
Service	<input checked="" type="checkbox"/>	Repair	<input type="checkbox"/>
optional <input type="checkbox"/>			
6002902000 Chain rivet tool			
 <p>6002902000</p>	Description/example of use Tool for riveting the chain		
	used with model Supermoto / Dual Sport Street Enduro Naked Bike		
Service	<input checked="" type="checkbox"/>	Repair	<input type="checkbox"/>
optional <input type="checkbox"/>			
79129081000 Mounting tool			
 <p>79129081000</p>	Description/example of use Tool for removing and installing components (coolant pipe)		
	Technical data Hexagonal driver: 13 mm (0.51 in) used with model FC 450 Rockstar Edition US 2018		
Service	<input type="checkbox"/>	Repair	<input checked="" type="checkbox"/>
optional <input type="checkbox"/>			

20.1 Wall tool organizer overview

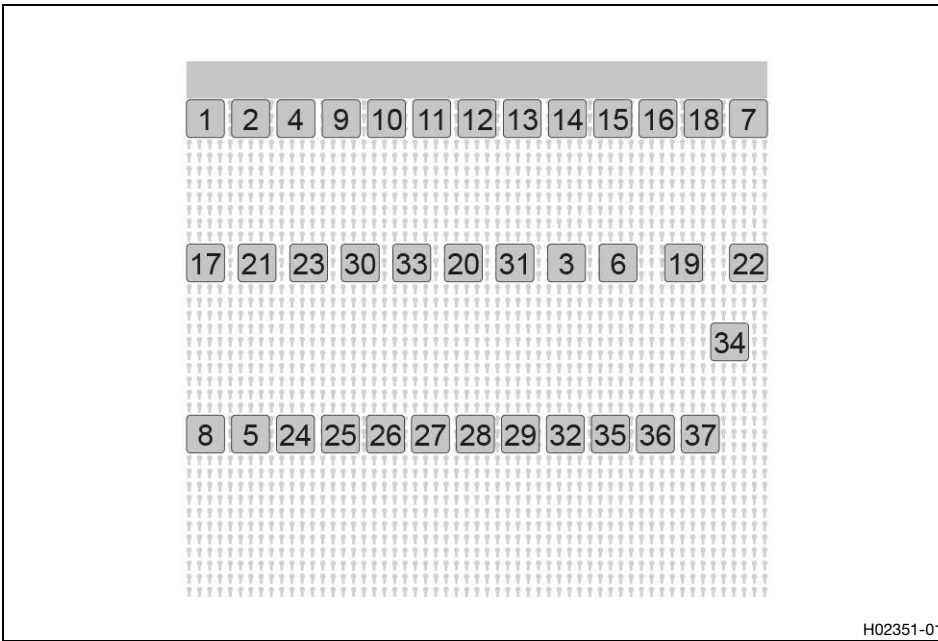

1	Pin wrench (T103) (📖 p. 106)
2	Drift (T120) (📖 p. 106)
3	Clamping stand (T1202S) (📖 p. 106)
4	Protecting sleeve (T1401) (📖 p. 107)
5	Clamping stand (T14015S) (📖 p. 107)
6	Clamping stand (T14016S) (📖 p. 107)
7	Ring wrench (T14017) (📖 p. 108)
8	Filling tool (T14019) (📖 p. 109)
9	Support tool (T14020) (📖 p. 109)
10	Calibrating unit (T14021) (📖 p. 109)
11	Pressing tool (T14022B) (📖 p. 110)
12	Thread protection sleeve (T14023) (📖 p. 110)
13	Support tool (T14026S) (📖 p. 110)
14	Support tool (T14026S1) (📖 p. 111)
15	Mounting sleeve (T14029) (📖 p. 111)
16	Filling adapter (T14030) (📖 p. 111)
17	Open end wrench (T14032) (📖 p. 112)
18	Tweezers (T14033) (📖 p. 112)
19	Clamping stand (T1403S) (📖 p. 112)
20	Mounting tool (T14040S) (📖 p. 113)
21	Groove nut wrench (T14047) (📖 p. 113)
22	Clamping stand (T14049S) (📖 p. 114)
23	Pressing tool (T14051) (📖 p. 115)
24	Clamping stand (T14072) (📖 p. 116)
25	Protecting sleeve (T14073) (📖 p. 116)
26	Special socket (T14084) (📖 p. 117)
27	Special socket (T14087) (📖 p. 117)
28	Ring wrench (T14091) (📖 p. 117)
29	Mounting sleeve (T14092) (📖 p. 118)
30	Protecting sleeve (T512) (📖 p. 118)
31	Mounting tool (T528S) (📖 p. 118)
32	Clamping stand (T531S) (📖 p. 118)
33	Pin (T605) (📖 p. 119)

- 34 Clamping stand (T612S) (📖 p. 119)
- 35 Mounting tool (T724S) (📖 p. 119)
- 36 Protecting sleeve (T726) (📖 p. 119)
- 37 Socket (T727S) (📖 p. 119)

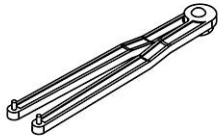
T103 Pin wrench								
<div style="text-align: center;">  <p>T103</p> </div>	<p>Description/example of use Tool for work on piston rod (spring holder, preload adjuster)</p> <p>Technical data adjustable Diameter: 4 mm (0.16 in) used with model TC 50 TC 65 TC 250 2014 FC 350 2014 FC 450 2014 TC 125 2014 FC 250 2014 Supermoto / Dual Sport FS 450 2015 FS 450 2016</p>	<table border="1" style="width: 100%; border-collapse: collapse;"> <tr> <td style="text-align: center;">Service</td> <td style="text-align: center;"><input type="checkbox"/></td> <td style="text-align: center;">Repair</td> <td style="text-align: center;"><input checked="" type="checkbox"/></td> <td style="text-align: center;">optional</td> <td style="text-align: center;"><input type="checkbox"/></td> </tr> </table>	Service	<input type="checkbox"/>	Repair	<input checked="" type="checkbox"/>	optional	<input type="checkbox"/>
Service	<input type="checkbox"/>	Repair	<input checked="" type="checkbox"/>	optional	<input type="checkbox"/>			

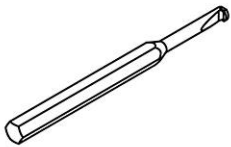
T120 Drift								
<div style="text-align: center;">  <p>T120</p> </div>	<p>Description/example of use Tool for driving components out (collar bushings)</p> <p>Technical data Diameter: 8 mm (0.31 in) used with model TC 50 TC 65 TC 85 2018 MX Enduro E1 Enduro E2 Enduro E3 Cross Country Supermoto Street Enduro Naked Mid</p>	<table border="1" style="width: 100%; border-collapse: collapse;"> <tr> <td style="text-align: center;">Service</td> <td style="text-align: center;"><input type="checkbox"/></td> <td style="text-align: center;">Repair</td> <td style="text-align: center;"><input checked="" type="checkbox"/></td> <td style="text-align: center;">optional</td> <td style="text-align: center;"><input type="checkbox"/></td> </tr> </table>	Service	<input type="checkbox"/>	Repair	<input checked="" type="checkbox"/>	optional	<input type="checkbox"/>
Service	<input type="checkbox"/>	Repair	<input checked="" type="checkbox"/>	optional	<input type="checkbox"/>			

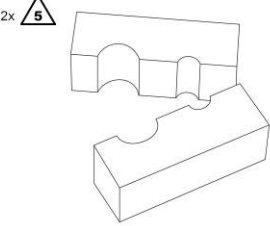
T1202S Clamping stand		
<div style="text-align: center;">  <p>T1202S</p> </div>	<p>Description/example of use Tool for clamping components (fluid barrier needle)</p> <p>Technical data Diameter: 10 mm (0.39 in) Diameter: 18 mm (0.71 in) used with model FE 250 2016 FE 350 2016 FE 350 S 2016 FE 450 2016</p>	

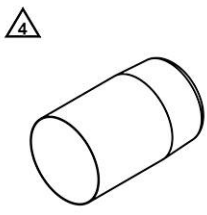
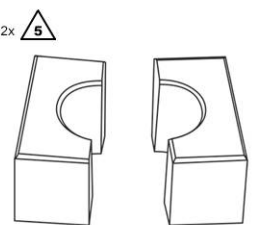
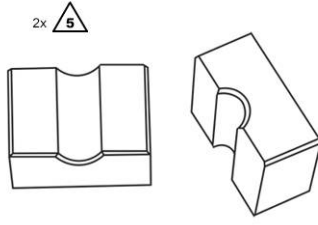
T1202S Clamping stand			
		FE 501 2016	
		FE 501 S 2016	
		Street Enduro	
		Service <input type="checkbox"/>	Repair <input checked="" type="checkbox"/>
		optional <input type="checkbox"/>	
T1401 Protecting sleeve			
 <p>T1401</p>		Description/example of use	
		Tool for protecting components (inside fork tube)	
		Technical data	
		Diameter: 48 mm (1.89 in)	
		used with model	
		TC 250 2015	
		TC 250 2016	
		TC 250 2017	
		TC 250 2018	
		MX1 4 stroke	
		MX2	
		Enduro E1	
		Enduro E2	
		Enduro E3	
		Cross Country	
		Supermoto	
		Street Enduro	
		Service <input type="checkbox"/>	Repair <input checked="" type="checkbox"/>
		optional <input type="checkbox"/>	
T14015S Clamping stand			
 <p>T14015S</p>		Description/example of use	
		Tool for clamping components (cartridge)	
		Technical data	
		Diameter: 27 mm (1.06 in)	
		used with model	
		TC 85 2018	
		Service <input type="checkbox"/>	Repair <input checked="" type="checkbox"/>
		optional <input type="checkbox"/>	
T14016S Clamping stand			
 <p>T14016S</p>		Description/example of use	
		Tool for clamping components (piston rod)	
		Technical data	
		Diameter: 12 mm (0.47 in)	
		used with model	
		Mini	
		TC 250 2014	
		TC 250 2017	
		TC 250 2018	
		FC 350 2014	
		FC 350 2017	
		FC 350 2018	
		FC 450 2014	
		FC 450 2017	
		FC 450 2018	
		TC 125 2014	
		TC 125 2017	

T14016S Clamping stand		
	TC 125 2018	
	FC 250 2014	
	FC 250 2017	
	FC 250 2018	
	TE 150	
	TX 125	
	FE 250 2017	
	FE 250 2018	
	TE 250 2017	
	TE 250 2018	
	FE 350 2017	
	FE 350 2018	
	FE 350 S 2017	
	FE 350 S 2018	
	FE 450 2017	
	FE 450 2018	
	TE 300 2017	
	TE 300 2018	
	FE 501 2017	
	FE 501 2018	
	FE 501 S 2017	
	FE 501 S 2018	
	Cross Country	
	Supermoto Competition	
	Service <input type="checkbox"/>	Repair <input checked="" type="checkbox"/>
		optional <input type="checkbox"/>

T14017 Ring wrench	
 <p>T14017</p>	<p>Description/example of use</p> <p>Tool for loosening and tightening components (cartridge)</p> <p>Technical data</p> <p>Hexagonal part: 50 mm (1.97 in)</p> <p>used with model</p> <p>TC 250 2014</p> <p>TC 250 2017</p> <p>TC 250 2018</p> <p>FC 350 2014</p> <p>FC 350 2017</p> <p>FC 350 2018</p> <p>FC 450 2014</p> <p>FC 450 2017</p> <p>FC 450 2018</p> <p>TC 125 2014</p> <p>TC 125 2017</p> <p>TC 125 2018</p> <p>FC 250 2014</p> <p>FC 250 2017</p> <p>FC 250 2018</p> <p>TE 150</p> <p>TX 125</p> <p>FE 250 2017</p> <p>FE 250 2018</p> <p>TE 250 2017</p> <p>TE 250 2018</p>

T14017 Ring wrench		
	FE 350 2017	
	FE 350 2018	
	FE 350 S 2017	
	FE 350 S 2018	
	FE 450 2017	
	FE 450 2018	
	TE 300 2017	
	TE 300 2018	
	FE 501 2017	
	FE 501 2018	
	FE 501 S 2017	
	FE 501 S 2018	
	Cross Country	
	Supermoto Competition	
Service	<input type="checkbox"/>	Repair <input checked="" type="checkbox"/> optional <input type="checkbox"/>

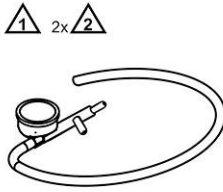

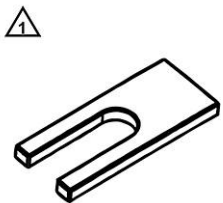
T14019 Filling tool		
 <p>T14019</p>	Description/example of use	
	Tool for filling the cartridge with nitrogen	
	used with model	
	TC 250 2014	
	FC 350 2014	
	FC 450 2014	
	TC 125 2014	
	FC 250 2014	
	FS 450 2015	
	FS 450 2016	
Service	<input type="checkbox"/>	Repair <input checked="" type="checkbox"/> optional <input type="checkbox"/>

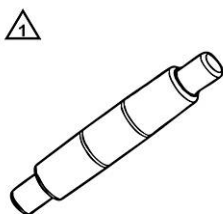
T14020 Support tool		
 <p>T14020</p>	Description/example of use	
	Tool for holding the piston rod	
	used with model	
	TC 250 2014	
	FC 350 2014	
	FC 450 2014	
	TC 125 2014	
	FC 250 2014	
	FS 450 2015	
	FS 450 2016	
Service	<input type="checkbox"/>	Repair <input checked="" type="checkbox"/> optional <input type="checkbox"/>

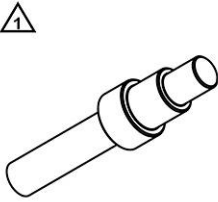
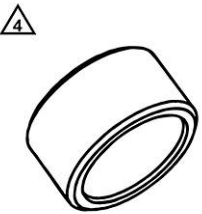
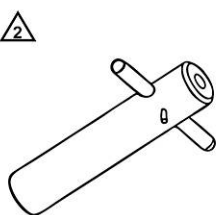
T14021 Calibrating unit		
 <p>T14021</p>	Description/example of use	
	Tool for calibrating components (DU bush)	
	Technical data	
	Diameter: 12 mm (0.47 in)	
	used with model	
	TC 50	
	TC 65	
TC 250 2014		
FC 350 2014		

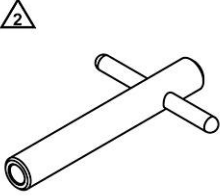
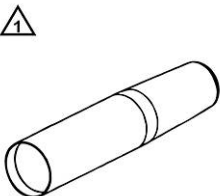
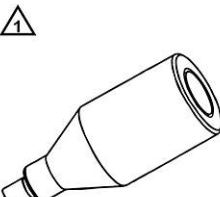
T14021 Calibrating unit			
	FC 450 2014 TC 125 2014 FC 250 2014 FS 450 2015 FS 450 2016		
	Service <input type="checkbox"/>	Repair <input checked="" type="checkbox"/>	optional <input type="checkbox"/>
T14022B Pressing tool			
 <p>T14022B</p>	<p>Description/example of use Tool for removing and installing components (DU bush)</p> <p>Technical data Diameter: 11.95 ... 21.4 mm (0.4705 ... 0.843 in)</p> <p>used with model TC 50 TC 65 TC 250 2014 FC 350 2014 FC 450 2014 TC 125 2014 FC 250 2014 FS 450 2015 FS 450 2016</p>		
	Service <input type="checkbox"/>	Repair <input checked="" type="checkbox"/>	optional <input type="checkbox"/>
T14023 Thread protection sleeve			
 <p>T14023</p>	<p>Description/example of use Tool for protecting components (thread of screw sleeve)</p> <p>Technical data Diameter: 24.5 mm (0.965 in)</p> <p>used with model TC 250 2014 FC 350 2014 FC 450 2014 TC 125 2014 FC 250 2014 FS 450 2015 FS 450 2016</p>		
	Service <input type="checkbox"/>	Repair <input checked="" type="checkbox"/>	optional <input type="checkbox"/>
T14026S Support tool			
 <p>T14026S</p>	<p>Description/example of use Tool for assembling the fork legs (pulling out piston rod)</p> <p>Technical data M14 Diameter: 25 mm (0.98 in)</p> <p>used with model TC 85</p>		
	Service <input type="checkbox"/>	Repair <input checked="" type="checkbox"/>	optional <input type="checkbox"/>

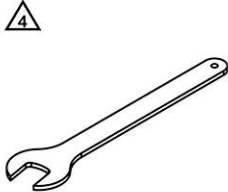
T14026S1 Support tool		
 <p>T14026S1</p>	<p>Description/example of use Tool for assembling the fork legs (pulling out piston rod)</p> <p>Technical data M12 Diameter: 17 mm (0.67 in)</p> <p>used with model</p> <p>TE 150 TX 125 FE 250 2017 FE 250 2018 TE 250 2017 TE 250 2018 FE 350 2017 FE 350 2018 FE 350 S 2017 FE 350 S 2018 FE 450 2017 FE 450 2018 TE 300 2017 TE 300 2018 FE 501 2017 FE 501 2018 FE 501 S 2017 FE 501 S 2018 Supermoto / Dual Sport</p>	<p>Service <input type="checkbox"/></p> <p>Repair <input checked="" type="checkbox"/></p> <p>optional <input type="checkbox"/></p>
T14029 Mounting sleeve		
 <p>T14029</p>	<p>Description/example of use Tool for mounting components (seal ring)</p> <p>Technical data Diameter: 12.45 mm (0.4902 in)</p> <p>used with model</p> <p>TC 250 2014 FC 350 2014 FC 450 2014 TC 125 2014 FC 250 2014 FS 450 2015 FS 450 2016</p>	<p>Service <input type="checkbox"/></p> <p>Repair <input checked="" type="checkbox"/></p> <p>optional <input type="checkbox"/></p>
T14030 Filling adapter		
 <p>T14030</p>	<p>Description/example of use Tool for bleeding and filling cartridge</p> <p>Technical data M4 Diameter: 16 mm (0.63 in)</p> <p>used with model</p> <p>FC 350 2014 FC 450 2014 TC 125 2014</p>	<p>Service <input type="checkbox"/></p> <p>Repair <input checked="" type="checkbox"/></p> <p>optional <input type="checkbox"/></p>

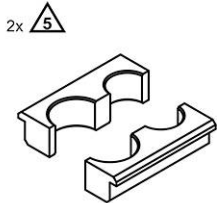
T14030 Filling adapter			
	FC 250 2014 FS 450 2015 FS 450 2016		
	Service <input type="checkbox"/>	Repair <input checked="" type="checkbox"/>	optional <input type="checkbox"/>
T14032 Open end wrench			
 <p>T14032</p>	<p>Description/example of use Tool for disassembling and assembling the fork legs</p> <p>Technical data Jaw opening: 22 mm (0.87 in)</p> <p>used with model TC 85 2014 TC 85 2015 TC 85 2016 TC 85 2017 Supermoto / Dual Sport</p>		
	Service <input type="checkbox"/>	Repair <input checked="" type="checkbox"/>	optional <input type="checkbox"/>
T14033 Tweezers			
 <p>T14033</p>	<p>Description/example of use Tool for mounting components (check valve)</p> <p>used with model TC 250 2014 FC 350 2014 FC 450 2014 TC 125 2014 FC 250 2014 FS 450 2015 FS 450 2016</p>		
	Service <input type="checkbox"/>	Repair <input checked="" type="checkbox"/>	optional <input type="checkbox"/>
T1403S Clamping stand			
 <p>T1403S</p>	<p>Description/example of use Tool for clamping components (fork legs, outer fork tube)</p> <p>Technical data Diameter: 48 mm (1.89 in) Diameter: 60 mm (2.36 in)</p> <p>used with model TC 50 TC 65 MX Enduro E1 Enduro E2 Enduro E3 Cross Country Supermoto Street Enduro</p>		
	Service <input type="checkbox"/>	Repair <input checked="" type="checkbox"/>	optional <input type="checkbox"/>

T14040S Mounting tool		
 <p>T14040S</p>	<p>Description/example of use</p> <p>Tool for holding when assembling fork legs</p> <p>Technical data</p> <p>Diameter: 48 mm (1.89 in)</p> <p>used with model</p> <p>TC 250 2015</p> <p>TC 250 2016</p> <p>TC 250 2017</p> <p>TC 250 2018</p> <p>MX1 4 stroke</p> <p>MX2</p> <p>Enduro E1</p> <p>Enduro E2</p> <p>Enduro E3</p> <p>Cross Country</p> <p>Supermoto</p> <p>Street Enduro</p>	
	Service <input type="checkbox"/>	Repair <input checked="" type="checkbox"/>

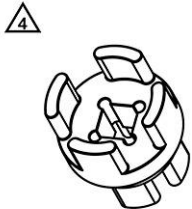
T14047 Groove nut wrench		
 <p>T14047</p>	<p>Description/example of use</p> <p>Tool for loosening and tightening components (screw cap)</p> <p>Technical data</p> <p>Drive: 1/2 in</p> <p>Narrow diameter: 34 mm (1.34 in)</p> <p>Wide diameter: 42.7 mm (1.681 in)</p> <p>used with model</p> <p>TC 250 2015</p> <p>TC 250 2016</p> <p>TC 250 2017</p> <p>TC 250 2018</p> <p>FC 350 2015</p> <p>FC 350 2016</p> <p>FC 350 2017</p> <p>FC 350 2018</p> <p>FC 450 2015</p> <p>FC 450 2016</p> <p>FC 450 2017</p> <p>FC 450 2018</p> <p>TC 125 2015</p> <p>TC 125 2016</p> <p>TC 125 2017</p> <p>TC 125 2018</p> <p>FC 250 2015</p> <p>FC 250 2016</p> <p>FC 250 2017</p> <p>FC 250 2018</p> <p>TE 125</p> <p>FE 250 2014</p> <p>FE 250 2015</p> <p>FE 250 2016</p> <p>TE 250 2014</p> <p>TE 250 2015</p>	

T14047 Groove nut wrench		
	TE 250 2016	
	FE 350 2014	
	FE 350 2015	
	FE 350 2016	
	FE 350 S 2015	
	FE 350 S 2016	
	FE 450 2014	
	FE 450 2015	
	FE 450 2016	
	TE 300 2014	
	TE 300 2015	
	TE 300 2016	
	FE 501 2014	
	FE 501 2015	
	FE 501 2016	
	FE 501 S 2015	
	FE 501 S 2016	
	Cross Country	
	FS 450 2017	
	FS 450 2018	
	Street Enduro	
	Service <input type="checkbox"/>	Repair <input checked="" type="checkbox"/>
		optional <input type="checkbox"/>

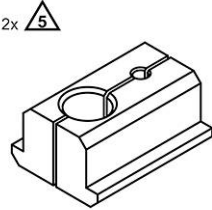
T14049S Clamping stand	
 <p>T14049S</p>	<p>Description/example of use Tool for clamping components (piston rod, cartridge)</p> <p>Technical data Diameter: 8 mm (0.31 in) Diameter: 24.8 mm (0.976 in)</p> <p>used with model</p> <p>TC 250 2015 TC 250 2016 FC 350 2015 FC 350 2016 FC 450 2015 FC 450 2016 TC 125 2015 TC 125 2016 FC 250 2015 FC 250 2016 TE 125 FE 250 2014 FE 250 2015 FE 250 2016 TE 250 2014 TE 250 2015 TE 250 2016 FE 350 2014 FE 350 2015 FE 350 2016 FE 350 S 2015 FE 350 S 2016 FE 450 2014</p>

T14049S Clamping stand		
	FE 450 2015	
	FE 450 2016	
	TE 300 2014	
	TE 300 2015	
	TE 300 2016	
	FE 501 2014	
	FE 501 2015	
	FE 501 2016	
	FE 501 S 2015	
	FE 501 S 2016	
	Street Enduro	
Service	<input type="checkbox"/>	Repair <input checked="" type="checkbox"/>
		optional <input type="checkbox"/>

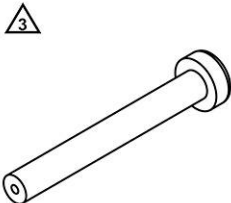
T14051 Pressing tool	
 <p>T14051</p>	<p>Description/example of use</p> <p>Tool for removing the cartridge from the fork leg</p> <p>Technical data</p> <p>Diameter: 27.5 mm (1.083 in)</p> <p>used with model</p> <p>TC 250 2015</p> <p>TC 250 2016</p> <p>FC 350 2015</p> <p>FC 350 2016</p> <p>FC 450 2015</p> <p>FC 450 2016</p> <p>TC 125 2015</p> <p>TC 125 2016</p> <p>FC 250 2015</p> <p>FC 250 2016</p> <p>TE 125</p> <p>FE 250 2014</p> <p>FE 250 2015</p> <p>FE 250 2016</p> <p>TE 250 2014</p> <p>TE 250 2015</p> <p>TE 250 2016</p> <p>FE 350 2014</p> <p>FE 350 2015</p> <p>FE 350 2016</p> <p>FE 350 S 2015</p> <p>FE 350 S 2016</p> <p>FE 450 2014</p> <p>FE 450 2015</p> <p>FE 450 2016</p> <p>TE 300 2014</p> <p>TE 300 2015</p> <p>TE 300 2016</p> <p>FE 501 2014</p> <p>FE 501 2015</p> <p>FE 501 2016</p>

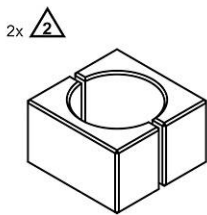
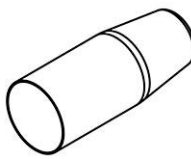
T14051 Pressing tool			
	FE 501 S 2015 FE 501 S 2016 Street Enduro		
	Service <input type="checkbox"/>	Repair <input checked="" type="checkbox"/>	optional <input type="checkbox"/>
T14072 Clamping stand			
 <p>T14072</p>	Description/example of use Tool for clamping components (cartridge)		
	Technical data Diameter: 37 mm (1.46 in) used with model TC 250 2017 TC 250 2018 FC 350 2017 FC 350 2018 FC 450 2017 FC 450 2018 TC 125 2017 TC 125 2018 FC 250 2017 FC 250 2018 Cross Country FS 450 2017 FS 450 2018		
	Service <input type="checkbox"/>	Repair <input checked="" type="checkbox"/>	optional <input type="checkbox"/>
T14073 Protecting sleeve			
 <p>T14073</p>	Description/example of use Tool for protecting components (thread of piston rod)		
	Technical data Diameter: 11.5 mm (0.453 in) used with model TC 85 2018 TC 250 2017 TC 250 2018 FC 350 2017 FC 350 2018 FC 450 2017 FC 450 2018 TC 125 2017 TC 125 2018 FC 250 2017 FC 250 2018 Cross Country FS 450 2017 FS 450 2018		
	Service <input type="checkbox"/>	Repair <input checked="" type="checkbox"/>	optional <input type="checkbox"/>

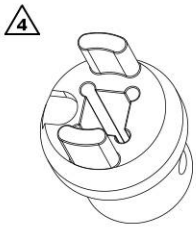
T14084 Special socket		
 <p>T14084</p>	Description/example of use Tool for loosening and tightening components (screw cap)	
	Technical data Drive: 1/2 in Diameter: 24 mm (0.94 in) used with model TC 50 TC 65	
Service	<input type="checkbox"/>	Repair <input checked="" type="checkbox"/> optional <input type="checkbox"/>

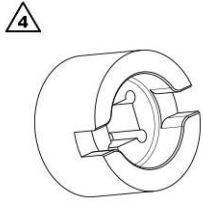
T14087 Special socket		
 <p>T14087</p>	Description/example of use Tool for loosening and tightening components (preload adjuster)	
	Technical data Drive: 1/2 in External diameter: 44 mm (1.73 in) Internal diameter: 29.5 mm (1.161 in) used with model TE 150 TX 125 FE 250 2017 FE 250 2018 TE 250 2017 TE 250 2018 FE 350 2017 FE 350 2018 FE 350 S 2017 FE 350 S 2018 FE 450 2017 FE 450 2018 TE 300 2017 TE 300 2018 FE 501 2017 FE 501 2018 FE 501 S 2017 FE 501 S 2018	
Service	<input type="checkbox"/>	Repair <input checked="" type="checkbox"/> optional <input type="checkbox"/>

T14091 Ring wrench		
 <p>T14091</p>	Description/example of use Tool for loosening and tightening components (screw cap)	
	Technical data Hexagonal part: 45 mm (1.77 in) used with model TC 85 2018	
Service	<input type="checkbox"/>	Repair <input checked="" type="checkbox"/> optional <input type="checkbox"/>

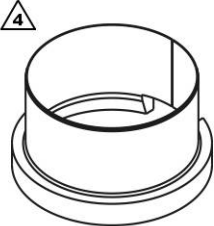
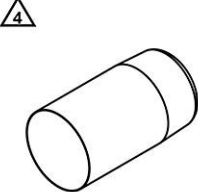
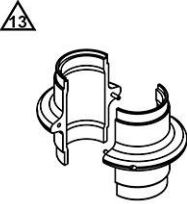
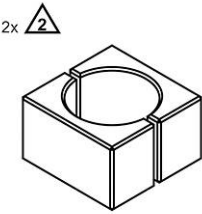
T14092 Mounting sleeve			
 <p>T14092</p>	Description/example of use Tool for mounting components (piston rod in the air cartridge)		
	Technical data Diameter: 34 mm (1.34 in) used with model TC 85 2018 TC 250 2018 FC 350 2018 FC 450 2018 TC 125 2018 FC 250 2018 FX 350 2018 FX 450 2018 TX 300 2018 FS 450 2018		
Service	<input type="checkbox"/>	Repair	<input checked="" type="checkbox"/>
		optional	<input type="checkbox"/>
T512 Protecting sleeve			
 <p>T512</p>	Description/example of use Tool for protecting components (inner tube)		
	Technical data Diameter: 43 mm (1.69 in) used with model TC 85 Naked Bike		
Service	<input type="checkbox"/>	Repair	<input checked="" type="checkbox"/>
		optional	<input type="checkbox"/>
T528S Mounting tool			
 <p>T528S</p>	Description/example of use Tool for holding when assembling fork legs		
	Technical data Diameter: 43 mm (1.69 in) used with model TC 85 Naked Bike		
Service	<input type="checkbox"/>	Repair	<input checked="" type="checkbox"/>
		optional	<input type="checkbox"/>
T531S Clamping stand			
 <p>T531S</p>	Description/example of use Tool for clamping components (air cartridge)		
	Technical data Diameter: 38 mm (1.5 in) used with model TC 85 2018		
Service	<input type="checkbox"/>	Repair	<input checked="" type="checkbox"/>
		optional	<input type="checkbox"/>

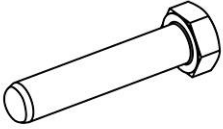
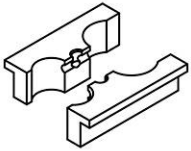
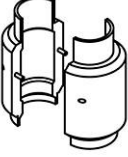
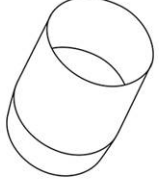
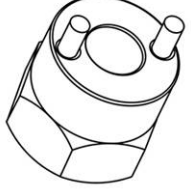
T605 Pin			
 <p>T605</p>	Description/example of use Tool for disassembling and assembling the cartridge		
	Technical data Diameter: 8 mm (0.31 in) used with model TC 85 2014 TC 85 2015 TC 85 2016 TC 85 2017		
Service	<input type="checkbox"/>	Repair	<input checked="" type="checkbox"/>
		optional	<input type="checkbox"/>
T612S Clamping stand			
 <p>T612S</p>	Description/example of use Tool for clamping components (outer tube, fork leg)		
	Technical data Diameter: 40 mm (1.57 in) Diameter: 54 mm (2.13 in) used with model TC 85 Naked Bike		
Service	<input type="checkbox"/>	Repair	<input checked="" type="checkbox"/>
		optional	<input type="checkbox"/>
T724S Mounting tool			
 <p>T724S</p>	Description/example of use Tool for holding when assembling fork legs		
	Technical data Diameter: 35 mm (1.38 in) used with model TC 50 TC 65		
Service	<input type="checkbox"/>	Repair	<input checked="" type="checkbox"/>
		optional	<input type="checkbox"/>
T726 Protecting sleeve			
 <p>T726</p>	Description/example of use Tool for protecting components (inner tube)		
	Technical data Diameter: 35 mm (1.38 in) used with model TC 50 TC 65		
Service	<input type="checkbox"/>	Repair	<input checked="" type="checkbox"/>
		optional	<input type="checkbox"/>
T727S Socket			
 <p>T727S</p>	Description/example of use Tool for loosening and tightening components (sliding bushing support)		
	Technical data Hexagonal part: 32 mm (1.26 in) Hole diameter: 14 mm (0.55 in) Pin diameter: 5 mm (0.2 in) used with model TC 50 TC 65		
Service	<input type="checkbox"/>	Repair	<input checked="" type="checkbox"/>
		optional	<input type="checkbox"/>

21.1 Overview

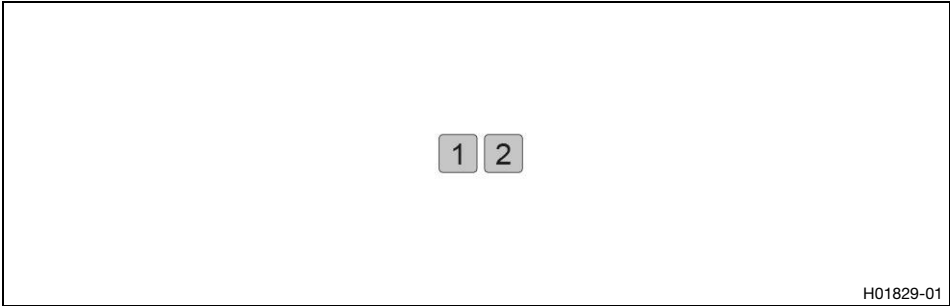

H01829-01

1 Vacuum pump (T1240S) (📖 p. 120)

1 Spring compressor (T14050S) (📖 p. 120)

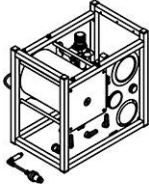
T1240S Vacuum pump			
 <p>T1240S</p>	Description/example of use Tool for bleeding and filling dampers		
	used with model Mini MX Enduro E1 Enduro E2 Enduro E3 Cross Country Supermoto Street Enduro		
Service	<input type="checkbox"/>	Repair	<input checked="" type="checkbox"/>
		optional	<input type="checkbox"/>

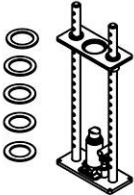
T14050S Spring compressor			
 <p>T14050S</p>	Description/example of use Tool for removing and installing springs		
	used with model TC 65 Naked Bike		
Service	<input type="checkbox"/>	Repair	<input checked="" type="checkbox"/>
		optional	<input type="checkbox"/>

21.2 Wall tool organizer overview

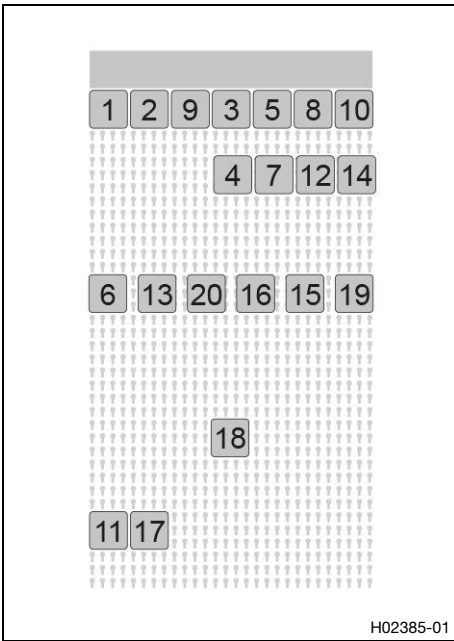

1	Hook wrench (T106S) (📖 p. 121)
2	Depth micrometer (T107S) (📖 p. 122)
3	Mounting sleeve (T1204) (📖 p. 122)
4	Calibrating unit (T1205) (📖 p. 123)
5	Pressing tool (T1206) (📖 p. 123)
6	Pressing tool (T1207S) (📖 p. 123)
7	Mounting sleeve (T1215) (📖 p. 124)
8	Pressing tool (T1216) (📖 p. 125)
9	Pin wrench (T1218) (📖 p. 125)
10	Pressing tool (T129) (📖 p. 125)
11	Filling adapter (T1296) (📖 p. 125)
12	Pressing tool (T1504) (📖 p. 126)
13	Mounting tool (T150S) (📖 p. 126)
14	Mounting sleeve (T1515) (📖 p. 127)
15	Hook wrench (T1533) (📖 p. 127)
16	Mounting sleeve (T1554) (📖 p. 128)
17	Filling adapter (T1565) (📖 p. 128)
18	Filling tool (T170S1) (📖 p. 128)
19	Hook wrench (T304) (📖 p. 128)
20	Mounting sleeve (T313) (📖 p. 129)

T106S Hook wrench

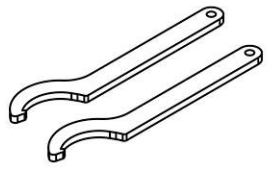

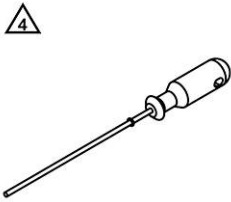
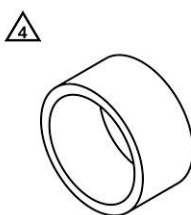

T106S

Description/example of use	
Tool for tensioning and releasing the springs (2 units)	
Technical data	
Diameter: 68 ... 75 mm (2.68 ... 2.95 in)	
used with model	
TC 85 2014	
TC 85 2015	
TC 85 2016	
TC 85 2017	
TC 250 2014	
TC 250 2015	
TC 250 2016	
FC 350 2014	
FC 350 2015	
FC 350 2016	
FC 450 2014	
FC 450 2015	
FC 450 2016	
TC 125 2014	
TC 125 2015	
TC 125 2016	
FC 250 2014	
FC 250 2015	
FC 250 2016	
TE 125	
FE 250 2014	
FE 250 2015	
FE 250 2016	
TE 250 2014	

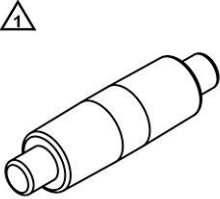
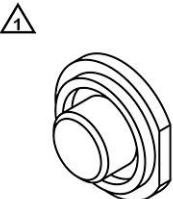
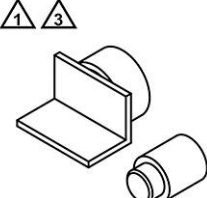
T106S Hook wrench		
	TE 250 2015 TE 250 2016 FE 350 2014 FE 350 2015 FE 350 2016 FE 350 S 2015 FE 350 S 2016 FE 450 2014 FE 450 2015 FE 450 2016 TE 300 2014 TE 300 2015 TE 300 2016 FE 501 2014 FE 501 2015 FE 501 2016 FE 501 S 2015 FE 501 S 2016 Supermoto / Dual Sport FS 450 2015 FS 450 2016 Street Enduro Naked Bike	
	Service <input checked="" type="checkbox"/>	Repair <input type="checkbox"/> optional <input type="checkbox"/>
T107S Depth micrometer		
 <p>T107S</p>	Description/example of use Tool for determining distances used with model Mini MX Enduro E1 Enduro E2 Enduro E3 Cross Country Supermoto Street Enduro	
	Service <input type="checkbox"/>	Repair <input checked="" type="checkbox"/> optional <input type="checkbox"/>
T1204 Mounting sleeve		
 <p>T1204</p>	Description/example of use Tool for mounting and pressing out components (dirt scraper, DU bush) Technical data Diameter: 25.5 ... 30.5 mm (1.004 ... 1.201 in) used with model Mini MX Enduro E1 Enduro E2	

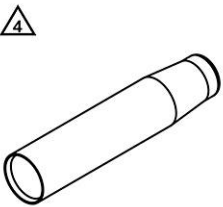

T1204 Mounting sleeve			
		Enduro E3 Cross Country Supermoto Competition	
		Service <input type="checkbox"/>	Repair <input checked="" type="checkbox"/> optional <input type="checkbox"/>
T1205 Calibrating unit			
 <p>T1205</p>	Description/example of use Tool for calibrating components (DU bush)		
	Technical data Diameter: 18 mm (0.71 in) used with model MX Enduro E1 Enduro E2 Enduro E3 Cross Country Supermoto Competition		
		Service <input type="checkbox"/>	Repair <input checked="" type="checkbox"/> optional <input type="checkbox"/>
T1206 Pressing tool			
 <p>T1206</p>	Description/example of use Tool for pressing in components (heim joint)		
	Technical data Diameter: 15 ... 30 mm (0.59 ... 1.18 in) used with model Mini MX Enduro E1 Enduro E2 Enduro E3 Cross Country Supermoto Street Enduro Naked Mid		
		Service <input type="checkbox"/>	Repair <input checked="" type="checkbox"/> optional <input type="checkbox"/>
T1207S Pressing tool			
 <p>T1207S</p>	Description/example of use Tool for pressing in components (heim joint)		
	used with model Mini MX Enduro E1 Enduro E2 Enduro E3 Cross Country Supermoto Street Enduro Naked Mid		
		Service <input type="checkbox"/>	Repair <input checked="" type="checkbox"/> optional <input type="checkbox"/>

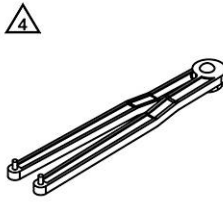
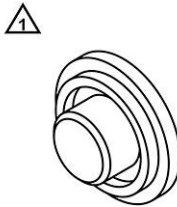
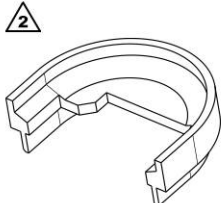
T1215 Mounting sleeve		
 <p>T1215</p>	<p>Description/example of use Tool for mounting components (seal ring retainer of piston rod)</p> <p>Technical data Diameter: 18 mm (0.71 in)</p> <p>used with model</p> <p>TC 250 2014 TC 250 2015 TC 250 2016 FC 350 2014 FC 350 2015 FC 350 2016 FC 450 2014 FC 450 2015 FC 450 2016 TC 125 2014 TC 125 2015 TC 125 2016 FC 250 2014 FC 250 2015 FC 250 2016 TE 125 FE 250 2014 FE 250 2015 FE 250 2016 TE 250 2014 TE 250 2015 TE 250 2016 FE 350 2014 FE 350 2015 FE 350 2016 FE 350 S 2015 FE 350 S 2016 FE 450 2014 FE 450 2015 FE 450 2016 TE 300 2014 TE 300 2015 TE 300 2016 FE 501 2014 FE 501 2015 FE 501 2016 FE 501 S 2015 FE 501 S 2016 FS 450 2015 FS 450 2016</p>	
Service	<input type="checkbox"/>	Repair
	<input checked="" type="checkbox"/>	optional
		<input type="checkbox"/>

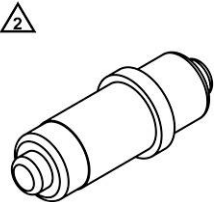
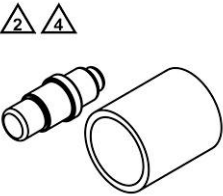
T1216 Pressing tool		
 <p>T1216</p>	<p>Description/example of use Tool for pressing in components (seal ring retainer of piston rod)</p> <p>Technical data Diameter: 38 ... 49 mm (1.5 ... 1.93 in) used with model MX Enduro E1 Enduro E2 Enduro E3 Cross Country Supermoto Competition</p>	<p>Service <input type="checkbox"/> Repair <input checked="" type="checkbox"/> optional <input type="checkbox"/></p>
T1218 Pin wrench		
 <p>T1218</p>	<p>Description/example of use Tool for removing components (rebound damping adjustment of piston rod)</p> <p>Technical data adjustable Diameter: 3 mm (0.12 in) used with model TC 50 TC 65 TC 85 2014 TC 85 2015 TC 85 2016 TC 85 2017</p>	<p>Service <input type="checkbox"/> Repair <input checked="" type="checkbox"/> optional <input type="checkbox"/></p>
T129 Pressing tool		
 <p>T129</p>	<p>Description/example of use Tool for pressing in components (heim joint)</p> <p>Technical data Diameter: 15 ... 30 mm (0.59 ... 1.18 in) used with model TC 50 2018 Supermoto / Dual Sport Street Enduro</p>	<p>Service <input type="checkbox"/> Repair <input checked="" type="checkbox"/> optional <input type="checkbox"/></p>
T1296 Filling adapter		
 <p>T1296</p>	<p>Description/example of use Adapter for filling tool for filling the damper with nitrogen</p> <p>used with model TC 50 TC 250 2017 TC 250 2018 FC 350 2017 FC 350 2018 FC 450 2017 FC 450 2018 TC 125 2017 TC 125 2018</p>	<p>for use with T170S1</p>

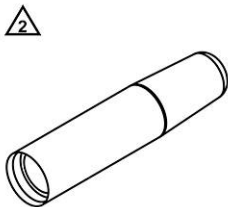
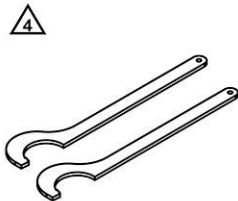
T1296 Filling adapter			
	FC 250 2017		
	FC 250 2018		
	TE 150		
	TX 125		
	FE 250 2017		
	FE 250 2018		
	TE 250 2017		
	TE 250 2018		
	FE 350 2017		
	FE 350 2018		
	FE 450 2017		
	FE 450 2018		
	TE 300 2017		
	TE 300 2018		
	FE 501 2017		
	FE 501 2018		
	FE 501 S 2017		
	FE 501 S 2018		
	Cross Country		
	FS 450 2017		
	FS 450 2018		
	Service	<input type="checkbox"/>	Repair <input checked="" type="checkbox"/> optional <input type="checkbox"/>
T1504 Pressing tool			
 <p>T1504</p>	Description/example of use		
	Tool for positioning components (DU bush in seal ring retainer)		
	Technical data		
	Diameter: 18 mm (0.71 in)		
	used with model		
	MX		
	Enduro E1		
	Enduro E2		
	Enduro E3		
	Cross Country		
	Supermoto Competition		
	Service	<input type="checkbox"/>	Repair <input checked="" type="checkbox"/> optional <input type="checkbox"/>
T150S Mounting tool			
 <p>T150S</p>	Description/example of use		
	Tool for pressing in components (DU bush in seal ring retainer)		
	used with model		
	MX		
	Enduro E1		
	Enduro E2		
	Enduro E3		
	Cross Country		
	Supermoto Competition		
	Service	<input type="checkbox"/>	Repair <input checked="" type="checkbox"/> optional <input type="checkbox"/>

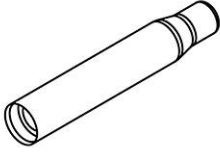
T1515 Mounting sleeve			
 <p>T1515</p>	<p>Description/example of use</p> <p>Tool for mounting components (seal ring retainer on piston rod)</p> <p>Technical data</p> <p>Diameter: 18 mm (0.71 in)</p> <p>used with model</p> <p>TC 85</p> <p>TC 250 2017</p> <p>TC 250 2018</p> <p>FC 350 2017</p> <p>FC 350 2018</p> <p>FC 450 2017</p> <p>FC 450 2018</p> <p>TC 125 2017</p> <p>TC 125 2018</p> <p>FC 250 2017</p> <p>FC 250 2018</p> <p>TE 150</p> <p>TX 125</p> <p>FE 250 2017</p> <p>FE 250 2018</p> <p>TE 250 2017</p> <p>TE 250 2018</p> <p>FE 350 2017</p> <p>FE 350 2018</p> <p>FE 350 S 2017</p> <p>FE 350 S 2018</p> <p>FE 450 2017</p> <p>FE 450 2018</p> <p>TE 300 2017</p> <p>TE 300 2018</p> <p>FE 501 2017</p> <p>FE 501 2018</p> <p>FE 501 S 2017</p> <p>FE 501 S 2018</p> <p>Cross Country</p> <p>Supersmoto / Dual Sport</p> <p>FS 450 2017</p> <p>FS 450 2018</p> <p>Street Enduro</p>		
	Service	<input type="checkbox"/>	Repair
		optional	<input type="checkbox"/>
T1533 Hook wrench			
 <p>T1533</p>	<p>Description/example of use</p> <p>Tool for tensioning and releasing the springs (2 units)</p> <p>Technical data</p> <p>Diameter: 59 mm (2.32 in)</p> <p>used with model</p> <p>TC 50</p>		
	Service	<input checked="" type="checkbox"/>	Repair
		optional	<input type="checkbox"/>

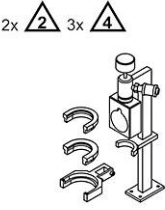
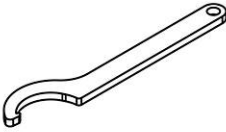
T1554 Mounting sleeve		
 <p>T1554</p>	<p>Description/example of use Tool for mounting components (seal ring retainer on piston rod)</p> <p>Technical data Diameter: 18 mm (0.71 in)</p> <p>used with model TC 85 2018</p>	<p>Service <input type="checkbox"/></p> <p>Repair <input checked="" type="checkbox"/></p> <p>optional <input type="checkbox"/></p>
T1565 Filling adapter		
 <p>T1565</p>	<p>Description/example of use Adapter for filling tool for filling the damper with nitrogen</p> <p>used with model TC 85 2018</p>	<p>for use with T170S1</p> <p>Service <input type="checkbox"/></p> <p>Repair <input checked="" type="checkbox"/></p> <p>optional <input type="checkbox"/></p>
T170S1 Filling tool		
 <p>T170S1</p>	<p>Description/example of use Tool for filling the damper with nitrogen</p> <p>used with model</p> <p>Mini MX Enduro E1 Enduro E2 Enduro E3 Cross Country Supermoto Street Enduro</p>	<p>matching tools / articles are T1296 T1565</p> <p>Service <input type="checkbox"/></p> <p>Repair <input checked="" type="checkbox"/></p> <p>optional <input type="checkbox"/></p>
T304 Hook wrench		
 <p>T304</p>	<p>Description/example of use Tool for tensioning and releasing the springs</p> <p>Technical data Diameter: 58 ... 62 mm (2.28 ... 2.44 in)</p> <p>used with model TC 50 TC 65</p>	<p>Service <input checked="" type="checkbox"/></p> <p>Repair <input type="checkbox"/></p> <p>optional <input type="checkbox"/></p>

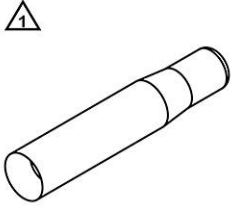

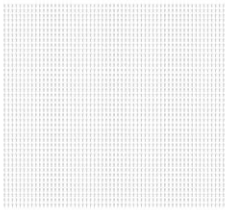
T313 Mounting sleeve				
 <p>T313</p>	<p>Description/example of use</p> <p>Tool for mounting components (seal ring retainer on piston rod)</p> <p>Technical data</p> <p>Diameter: 14 mm (0.55 in)</p> <p>used with model</p> <p>TC 50</p> <p>TC 65</p>			
	Service	<input type="checkbox"/>	Repair	<input checked="" type="checkbox"/>
			optional	<input type="checkbox"/>

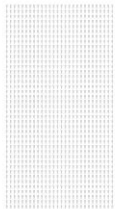



1086001 Tool panel		
 <p>1086001</p>	<p>Description/example of use</p> <p>Grey perforated panel for hanging tools, the number of tool panels required is determined by size of the tools and the specific local circumstances (one unit included)</p> <p>Technical data</p> <p>Wall mounting elements included: 9 pcs</p> <p>Width: 1,050 mm (41.34 in)</p> <p>Height: 1,000 mm (39.37 in)</p>	
	<p>matching tools / articles are</p> <p>2086403</p> <p>2286005</p> <p>2286007</p>	
Service	<input checked="" type="checkbox"/>	Repair optional <input type="checkbox"/>

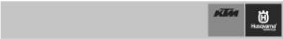
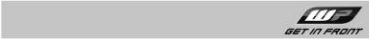

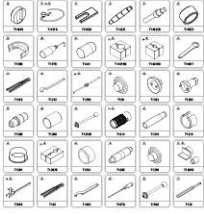

1086002 Tool panel		
 <p>1086002</p>	<p>Description/example of use</p> <p>Grey perforated panel for hanging tools, the number of tool panels required is determined by size of the tools and the specific local circumstances (one unit included)</p> <p>Technical data</p> <p>Wall mounting elements included: 6 pcs</p> <p>Width: 525 mm (20.67 in)</p> <p>Height: 1,000 mm (39.37 in)</p>	
	<p>matching tools / articles are</p> <p>2086404</p> <p>2286006</p> <p>2286008</p>	
Service	<input checked="" type="checkbox"/>	Repair optional <input type="checkbox"/>





2086403 Husqvarna Motorcycles header		
 <p>2086403</p>	<p>Description/example of use</p> <p>Sticker with Husqvarna Motorcycles logo for sticking on the tool panel</p> <p>Technical data</p> <p>Width: 1,050 mm (41.34 in)</p> <p>Height: 98 mm (3.86 in)</p>	
	<p>for use with</p> <p>1086001</p>	
Service	<input checked="" type="checkbox"/>	Repair optional <input type="checkbox"/>



2086404 Husqvarna Motorcycles header		
 <p>2086404</p>	<p>Description/example of use</p> <p>Sticker with Husqvarna Motorcycles logo for sticking on the tool panel</p> <p>Technical data</p> <p>Width: 525 mm (20.67 in)</p> <p>Height: 98 mm (3.86 in)</p>	
	<p>for use with</p> <p>1086002</p>	
Service	<input type="checkbox"/>	Repair optional <input type="checkbox"/>

2286005 KTM and Husqvarna header			
 <p>2286005</p>	Description/example of use Sticker with KTM and Husqvarna Motorcycles logo for sticking on the tool panel		
	Technical data for use with Width: 1,050 mm (41.34 in) 1086001 Height: 98 mm (3.86 in)		
Service <input checked="" type="checkbox"/>		Repair <input type="checkbox"/>	optional <input type="checkbox"/>
2286006 KTM and Husqvarna header			
 <p>2286006</p>	Description/example of use Sticker with KTM and Husqvarna Motorcycles logo for sticking on the tool panel		
	Technical data for use with Width: 525 mm (20.67 in) 1086002 Height: 98 mm (3.86 in)		
Service <input checked="" type="checkbox"/>		Repair <input type="checkbox"/>	optional <input type="checkbox"/>
2286007 WP header			
 <p>2286007</p>	Description/example of use Sticker with WP logo for sticking on the tool panel		
	Technical data for use with Width: 1,050 mm (41.34 in) 1086001 Height: 98 mm (3.86 in)		
Service <input checked="" type="checkbox"/>		Repair <input type="checkbox"/>	optional <input type="checkbox"/>
2286008 WP header			
 <p>2286008</p>	Description/example of use Sticker with WP logo for sticking on the tool panel		
	Technical data for use with Width: 525 mm (20.67 in) 1086002 Height: 98 mm (3.86 in)		
Service <input checked="" type="checkbox"/>		Repair <input type="checkbox"/>	optional <input type="checkbox"/>
4086601 Label kit			
 <p>4086601</p>	Description/example of use Sheet of labels including magnets covering all images of current tools which are supplied with brackets and magnetic labels. Scope changes continually as new tools are added		
	Spare parts		

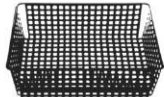
4086602 WP label kit	
 <p>4086602</p>	<p>Description/example of use</p> <p>Sheet of labels including magnets covering all images of current tools which are supplied with brackets and magnetic labels. Scope changes continually as new tools are added</p>
Spare parts	
3287001 Clamp	
 <p>3287001</p>	<p>Description/example of use</p> <p>Clamp for hanging tool (1 set = 10 units), incl. screws and nuts</p> <p>Technical data</p> <p>For tool with diameter: 0 ... 20 mm (0 ... 0.79 in)</p>
Spare parts	
3287002 Clamp	
 <p>3287002</p>	<p>Description/example of use</p> <p>Clamp for hanging tool (1 set = 10 units), incl. screws and nuts</p> <p>Technical data</p> <p>For tool with diameter: 15 ... 30 mm (0.59 ... 1.18 in)</p>
Spare parts	
3287003 Clamp	
 <p>3287003</p>	<p>Description/example of use</p> <p>Clamp for hanging tool (1 set = 10 units), incl. screws and nuts</p> <p>Technical data</p> <p>For tool with diameter: 25 ... 40 mm (0.98 ... 1.57 in)</p>
Spare parts	
3287004 Hook	
 <p>3287004</p>	<p>Description/example of use</p> <p>Hook for hanging tool (1 set = 10 units), incl. screws and nuts</p> <p>Technical data</p> <p>Lightweight version</p> <p>Hook length: 60 mm (2.36 in)</p>
Spare parts	

3287005 Hook	
 3287005	Description/example of use Hook for hanging tool (1 set = 10 units), incl. screws and nuts Technical data Lightweight version Hook length: 100 mm (3.94 in)
Spare parts	
3287006 Hook	
 3287006	Description/example of use Hook for hanging tool (1 set = 5 units), incl. screws and nuts Technical data Heavy-duty version Hook length: 120 mm (4.72 in)
Spare parts	
3287007 Hook	
 3287007	Description/example of use Hook for hanging tool (1 set = 5 units), incl. screws and nuts Technical data Heavy-duty version Hook length: 200 mm (7.87 in)
Spare parts	
3287008 Hook	
 3287008	Description/example of use Hook for hanging tool (1 set = 10 units), incl. screws and nuts Technical data Heavy duty, straight design Hook length: 100 mm (3.94 in)
Spare parts	
3287009 Hook	
 3287009	Description/example of use Hook for hanging tool (1 set = 5 units), incl. screws and nuts Technical data Rubberized version Hook length: 100 mm (3.94 in)
Spare parts	

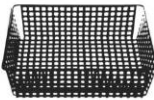
3287010 Hook	
 3287010	Description/example of use Hook for hanging tool (1 set = 10 units), incl. screws and nuts Technical data U-shaped design Hook length: 100 mm (3.94 in)
Spare parts	
3287011 Magnet holder	
 3287011	Description/example of use Magnet for holding tool (1 set = 5 units) Technical data Diameter: 45 mm (1.77 in)
Spare parts	
3287012 Metal box	
 3287012	Description/example of use Small wire mesh tray for keeping tools, incl. screws and nuts Technical data Length: 160 mm (6.3 in) Width: 110 mm (4.33 in) Height: 50 mm (1.97 in)
Spare parts	
3287013 Clamp	
 3287013	Description/example of use Clamp for hanging tool (1 set = 5 units), incl. screws and nuts Technical data For tool with diameter: 35 ... 70 mm (1.38 ... 2.76 in)
Spare parts	
3287014 Hook	
 3287014	Description/example of use Hook for hanging tool (1 set = 5 units), incl. screws and nuts Technical data Angled version Hook length: 100 mm (3.94 in)
Spare parts	

3287015 Hook	
 3287015	Description/example of use Hook for hanging tool (1 set = 5 units), incl. screws and nuts Technical data Angled version Hook length: 200 mm (7.87 in)
Spare parts	
3287016 Metal box	
 3287016	Description/example of use Large wire mesh tray for keeping tools, incl. screws and nuts Technical data Length: 270 mm (10.63 in) Width: 150 mm (5.91 in) Height: 50 mm (1.97 in)
Spare parts	
3287017 Hook	
 3287017	Description/example of use Hook for hanging tool (1 set = 10 units), incl. screws and nuts Technical data Circular design Diameter: 35 mm (1.38 in)
Spare parts	
3287018 Hook	
 3287018	Description/example of use Hook for hanging tool (1 set = 10 units), incl. screws and nuts Technical data U-shaped design Hook length: 50 mm (1.97 in)
Spare parts	

Husqvarna	
Offroad	
Mini	
Mini MX	
Mini MX 2 stroke	
TC 50	
TC 50 2017	TC 50 2017
TC 50 2018	TC 50 2018 TC 50 Mini 2018
TC 65	
TC 65 2017	TC 65 2017
TC 65 2018	TC 65 2018
TC 85	
TC 85 2014	TC 85 17/14 2014 TC 85 19/16 2014
TC 85 2015	TC 85 17/14 2015 TC 85 19/16 2015
TC 85 2016	TC 85 17/14 2016 TC 85 19/16 2016
TC 85 2017	TC 85 17/14 2017 TC 85 19/16 2017
TC 85 2018	TC 85 17/14 2018 TC 85 19/16 2018
MX	
MX1	
MX1 2 stroke	
TC 250	
TC 250 2014	TC 250 EU 2014
TC 250 2015	TC 250 2015
TC 250 2016	TC 250 2016
TC 250 2017	TC 250 2017
TC 250 2018	TC 250 2018
MX1 4 stroke	
FC 350	
FC 350 2014	FC 350 EU 2014
FC 350 2015	FC 350 EU 2015
FC 350 2016	

				FC 350 EU 2016
				FC 350 2017
				FC 350 2017
				FC 350 2018
				FC 350 2018
			FC 450	
				FC 450 2014
				FC 450 EU 2014
				FC 450 2015
				FC 450 EU 2015
				FC 450 US 2015
				FC 450 2016
				FC 450 2016
				FC 450 2017
				FC 450 2017
				FC 450 2018
				FC 450 2018
				FC 450 Rockstar Edition US 2018
		MX2		
			MX2 2 stroke	
				TC 125
				TC 125 2014
				TC 125 EU 2014
				TC 125 2015
				TC 125 EU 2015
				TC 125 2016
				TC 125 2016
				TC 125 2017
				TC 125 2017
				TC 125 2018
				TC 125 2018
			MX2 4 stroke	
				FC 250
				FC 250 2014
				FC 250 EU 2014
				FC 250 2015
				FC 250 EU 2015
				FC 250 US 2015
				FC 250 2016
				FC 250 2016
				FC 250 2017
				FC 250 2017
				FC 250 2018
				FC 250 2018
		Enduro		
			Enduro E1	
				Enduro E1 2 stroke
				TE 125
				TE 125 2014
				TE 125 EU 2014
				TE 125 2015
				TE 125 EU 2015
				TE 125 US 2015

				TE 125 2016
				TE 125 EU 2016
				TE 125 US 2016
			TE 150	
				TE 150 2017
				TE 150 US 2017
				TE 150 2018
				TE 150 US 2018
			TX 125	
				TX 125 2017
				TX 125 EU 2017
				TX 125 2018
				TX 125 EU 2018
			Enduro E1 4 stroke	
			FE 250	
				FE 250 2014
				FE 250 EU 2014
				FE 250 AU 2014
				FE 250 US 2014
				FE 250 2015
				FE 250 EU 2015
				FE 250 AU 2015
				FE 250 US 2015
				FE 250 2016
				FE 250 EU 2016
				FE 250 AU 2016
				FE 250 US 2016
				FE 250 2017
				FE 250 EU 2017
				FE 250 AU 2017
				FE 250 US 2017
				FE 250 2018
				FE 250 EU 2018
				FE 250 AU 2018
				FE 250 US 2018
			Enduro E2	
			Enduro E2 2 stroke	
			TE 250	
				TE 250 2014
				TE 250 EU 2014
				TE 250 AU 2014
				TE 250 US 2014
				TE 250 2015
				TE 250 EU 2015
				TE 250 AU 2015
				TE 250 US 2015
				TE 250 2016
				TE 250 EU 2016
				TE 250 AU 2016
				TE 250 US 2016
				TE 250 2017
				TE 250 EU 2017
				TE 250 AU 2017

TE 250 US 2017

TE 250 2018

TE 250i EU 2018

TE 250 AU 2018

TE 250 US 2018

TE 250i US 2018

Enduro E2 4 stroke**FE 350****FE 350 2014**

FE 350 EU 2014

FE 350 AU 2014

FE 350 US 2014

FE 350 2015

FE 350 EU 2015

FE 350 AU 2015

FE 350 US 2015

FE 350 2016

FE 350 EU 2016

FE 350 AU 2016

FE 350 US 2016

FE 350 2017

FE 350 EU 2017

FE 350 AU 2017

FE 350 2018

FE 350 EU 2018

FE 350 AU 2018

FE 350 S**FE 350 S 2015**

FE 350S US 2015

FE 350 S 2016

FE 350 S US 2016

FE 350 S 2017

FE 350 US 2017

FE 350 S 2018

FE 350 US 2018

FE 450**FE 450 2014**

FE 450 EU 2014

FE 450 AU 2014

FE 450 2015

FE 450 EU 2015

FE 450 AU 2015

FE 450 2016

FE 450 EU 2016

FE 450 AU 2016

FE 450 US 2016

FE 450 2017

FE 450 EU 2017

FE 450 AU 2017

FE 450 US 2017

FE 450 2018

FE 450 EU 2018

FE 450 AU 2018

FE 450 US 2018

Enduro E3**Enduro E3 2 stroke****TE 300****TE 300 2014**

TE 300 EU 2014

TE 300 AU 2014

TE 300 US 2014

TE 300 2015

TE 300 EU 2015

TE 300 AU 2015

TE 300 US 2015

TE 300 2016

TE 300 EU 2016

TE 300 AU 2016

TE 300 US 2016

TE 300 2017

TE 300 EU 2017

TE 300 AU 2017

TE 300 US 2017

TE 300 2018

TE 300i EU 2018

TE 300 AU 2018

TE 300 US 2018

Enduro E3 4 stroke**FE 501****FE 501 2014**

FE 501 EU 2014

FE 501 AU 2014

FE 501 US 2014

FE 501 2015

FE 501 EU 2015

FE 501 AU 2015

FE 501 US 2015

FE 501 2016

FE 501 EU 2016

FE 501 AU 2016

FE 501 US 2016

FE 501 2017

FE 501 EU 2017

FE 501 AU 2017

FE 501 2018

FE 501 EU 2018

FE 501 AU 2018

FE 501 S**FE 501 S 2015**

FE 501S US 2015

FE 501 S 2016

FE 501 S US 2016

FE 501 S 2017

FE 501 US 2017

FE 501 S 2018

FE 501 US 2018

	Rally		
		Rally 4 stroke	
			FR 450 Rally
			FR 450 Rally 2016
			FR 450 Rally 2016
			FR 450 Rally 2017
			FR 450 Rally 2017
	Cross Country		
		Cross Country E2	
			Cross Country E2 4 stroke
			FX 350
			FX 350 2017
			FX 350 2017
			FX 350 2018
			FX 350 2018
			FX 450
			FX 450 2017
			FX 450 2017
			FX 450 2018
			FX 450 2018
		Cross Country E3	
			Cross Country E3 2 stroke
			TX 300
			TX 300 2017
			TX 300 2017
			TX 300 2018
			TX 300 2018
Street			
	Supermoto		
		Supermoto / Dual Sport	
			Supermoto / Dual Sport SM Mid
			701 Supermoto
			701 Supermoto 2016
			701 Supermoto EU 2016
			701 Supermoto AU 2016
			701 Supermoto US 2016
			701 Supermoto 2017
			701 Supermoto EU 2017
			701 Supermoto US 2017
			701 Supermoto 2018
			701 Supermoto EU 2018
			701 Supermoto US 2018
		Supermoto Competition	
			Supermoto Competition 4 stroke
			FS 450
			FS 450 2015
			FS 450 2015
			FS 450 2016
			FS 450 2016
			FS 450 2017
			FS 450 2017
			FS 450 2018
			FS 450 2018

Street Enduro	
Dual Sport Enduro	
Dual Sport Enduro Mid	
701 Enduro	
701 Enduro 2016	
701 Enduro EU 2016	
701 Enduro AU 2016	
701 Enduro US 2016	
701 Enduro 2017	
701 Enduro EU 2017	
701 Enduro US 2017	
701 Enduro 2018	
701 Enduro EU 2018	
701 Enduro US 2018	
Naked Bike	
Naked Bike Naked	
Naked Small	
401 Vitpilen	
401 Vitpilen 2018	
VITPILEN 401 EU 2018	
401 Svartpilen	
401 Svartpilen 2018	
SVARTPILEN 401 EU 2018	
Naked Mid	
701 Vitpilen	
701 Vitpilen 2018	
VITPILEN 701 EU 2018	



3403044en

12.06.2018

